

GUNKUL

not only the energy, we care

CATALOG & PRICE LIST 2019



NOT
ONLY
THE
ENERGY,

WE
CARE

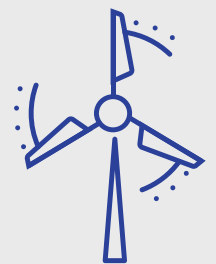

GUNKUL

not only the energy, we care

**GUNKUL ENGINEERING PUBLIC COMPANY LIMITED
1177 PEARL BANGKOK BUILDING, 8TH FLOOR,
PHAHOLYOTHIN RD, PHAYATHAI, PHAYATHAI,
BANGKOK 10400 THAILAND**

TEL : (662) 242-5800 (AUTO), โทรศัพท์ ต่อ : 5801-5814

FAX : (662) 242-5817-18, 242-5833

E-MAIL : GK_ENG@GUNKUL.COM

WEBSITE : WWW.GUNKUL.COM



วิสัยทัศน์

เป็นผู้นำด้านธุรกิจพลังงานทดแทนแบบ
ครบวงจร และธุรกิจระบบไฟฟ้า ด้วย
เทคโนโลยีชั้นนำเพื่อพัฒนาโครงสร้าง
พื้นฐานอย่างยั่งยืน



VISION

**BE A LEADER IN THE INTEGRATED
RENEWABLE ENERGY AND ELECTRICAL
SYSTEMS BUSINESS, IMPLEMENTING
STATE OF THE ART TECHNOLOGY FOR
SUSTAINABLE INFRASTRUCTURE
DEVELOPMENT.**

ข้อมูลบริษัท

บริษัท กันกุลเอ็นจิเนียริ่ง จำกัด (มหาชน) หนึ่งในเครือกันกุลกรุ๊ป เริ่มต้นมาจากร้านค้าฮาร์ดแวร์อุปกรณ์ไฟฟ้าและการค้าของเก่า เมื่อปี พ.ศ. 2505 ในนาม ร้านโจงะ จากวันนั้นร้านเล็กๆ ของกิจการในครอบครัวได้เติบโตขึ้นตามลำดับด้วยความมุ่งมั่นและวิสัยทัศน์ของผู้ก่อตั้ง และนักบริหารมืออาชีพที่มากประสบการณ์ คุณกัลกุล ดำรงปิยวุฒิ ในวันที่ 5 สิงหาคม 2525 บริษัท กันกุลเอ็นจิเนียริ่ง จำกัด ได้ก่อตั้งขึ้น โดยเริ่มจากการทำธุรกิจนำเข้า และจัดจำหน่ายอุปกรณ์สำหรับระบบไฟฟ้า จากนั้นจึงได้ขยายธุรกิจเป็นผู้ผลิตอุปกรณ์สำหรับระบบไฟฟ้า โดยในปี พ.ศ. 2535 ได้มีการก่อตั้ง บริษัท จี.เค.แอส เซ็มบลี จำกัด เพื่อผลิตและประกอบอุปกรณ์ต่างๆ สำหรับระบบไฟฟ้า และก่อตั้งบริษัท จี.เค.พาวเวอร์โปรดักส์ จำกัด เพื่อผลิตอุปกรณ์ป้องกันสำหรับระบบไฟฟ้าแรงสูงและแรงต่ำ ด้วยเครือข่ายทางธุรกิจที่เติบโตครอบคลุมและมีประสิทธิภาพ จึงส่งเสริมให้การดำเนินงานของกุ่มบริษัทกันกุลเติบโตอย่างไม่หยุดยั้ง

ต่อมาเพื่อรองรับการขยายตัวและการเติบโตทางด้านธุรกิจ บริษัทจึงได้ดำเนินการแปรสภาพเป็นบริษัทมหาชนจำกัด และเปลี่ยนชื่อเป็น บริษัท กันกุลเอ็นจิเนียริ่ง จำกัด (มหาชน) ก่อนที่จะมีการดำเนินการก่อสร้างโรงไฟฟ้าพลังงานแสงอาทิตย์ และดำเนินธุรกิจผลิตไฟฟ้าเพื่อจำหน่าย (Power Producer) โดยเน้นธุรกิจพลังงานทดแทน เพื่อตอบสนองนโยบายและความต้องการของกลุ่มลูกค้าทั้งภาครัฐและเอกชนที่ส่งเสริมให้มีการใช้พลังงานทางเลือกรูปแบบใหม่ที่จะช่วยลดการใช้น้ำมันเชื้อเพลิง และผลิตไฟฟ้าที่สะอาด รวมทั้งช่วยลดการปล่อยก๊าซเรือนกระจกที่เป็นสาเหตุภาวะโลกร้อนได้อีกทางหนึ่ง โดยบริษัทได้มีการขยายธุรกิจและมีการเพิ่มทุนจดทะเบียนอย่างต่อเนื่อง จนถึงปัจจุบันมีทุนจดทะเบียนกว่า 1,983 ล้านบาท และมีสินทรัพย์รวม 40,000 ล้านบาท

บริษัท กันกุลเอ็นจิเนียริ่ง จำกัด (มหาชน) เป็นหนึ่งในผู้ผลิตและจัดจำหน่ายอุปกรณ์สำหรับระบบไฟฟ้าที่ครอบคลุมทุกความต้องการของลูกค้า โดยแบ่งประเภทของสินค้าออกเป็น 9 กลุ่มใหญ่ ดังนี้

1. Grounding system and Lightning protection system
2. Cable accessories
3. Protective equipments (fuse, switch, surge arrester, live parts cover & animal protector)
4. Insulator, cable, hardware and accessories
5. Tools, hydraulic tool and safety tool
6. Measuring and instrument
7. Street lighting & accessories
8. Service and maintenance products
9. Conduit and tting

เพื่อให้ลูกค้าเชื่อมั่นในคุณภาพของสินค้าและบริการ ผลิตภัณฑ์ที่บริษัทจำหน่ายส่วนใหญ่ได้ผ่านการทดสอบคุณภาพตามมาตรฐานต่างๆ เช่น มอก., IEC, ANSI ทั้งจากสถาบันทดสอบในประเทศ และสถาบันทดสอบในต่างประเทศที่มีชื่อเสียง นอกจากนี้บริษัทและโรงงานในเครือกลุ่มบริษัทกันกุล ยังได้รับรองระบบบริหารคุณภาพตามมาตรฐาน ISO 9001 ระบบการ

จัดการสิ่งแวดล้อม ISO 14000 และด้วยระบบบริหารสินค้าคงคลังกับการจัดการด้านโลจิสติกส์ที่มีประสิทธิภาพในปัจจุบัน ทางบริษัทสามารถวางแผนในการจัดเก็บสต็อกสินค้าหลากหลายรายการในคลังสินค้าขนาดใหญ่ได้อย่างเหมาะสม ทำให้บริษัทสามารถให้บริการจัดหาสินค้าให้กับลูกค้าได้ด้วยความถูกต้อง สะดวก และรวดเร็ว ซึ่งได้สร้างความประทับใจให้กับลูกค้าทั้งในด้านคุณภาพของสินค้าและการบริการ

นอกจากอุปกรณ์ที่ผลิตภายใต้ตราสัญลักษณ์ GUNKUL ที่ผลิตโดยโรงงานในเครือของกลุ่มบริษัทแล้ว ยังมีผู้ผลิตอุปกรณ์สำหรับระบบไฟฟ้าที่มีชื่อเสียงเชื่อถือได้จากประเทศต่างๆ เช่น สหรัฐอเมริกา เยอรมัน ญี่ปุ่น และจีน เป็นต้น ได้มอบความไว้วางใจให้บริษัท กันกุลเอ็นจิเนียริ่ง จำกัด (มหาชน) เป็นตัวแทนจำหน่ายผลิตภัณฑ์อีกมากมาย ปัจจุบัน บริษัท กันกุลเอ็นจิเนียริ่ง จำกัด (มหาชน) จึงก้าวขึ้นเป็นผู้นำในตลาดการจัดจำหน่ายอุปกรณ์สำหรับระบบไฟฟ้าที่ได้มาตรฐานและเป็นที่ยอมรับของลูกค้าทั้งจากหน่วยงานภาครัฐและเอกชน เช่น การไฟฟ้าฝ่ายผลิตแห่งประเทศไทย การไฟฟ้านครหลวง การไฟฟ้าส่วนภูมิภาค, Siemens, ABB, PTT, SCG เป็นต้น รวมถึงมีการส่งออกสินค้าไปจำหน่ายยังต่างประเทศ เช่น ประเทศพม่า ลาว เวียดนาม มาเลเซีย

นอกจากนี้ บริษัทยังได้ขยายขอบเขตธุรกิจไปสู่การดำเนินธุรกิจในการออกแบบด้านวิศวกรรม การจัดหา และก่อสร้าง (EPC, Engineering Procurement & Construction) โดยบริษัท กันกุลเอ็นจิเนียริ่ง จำกัด (มหาชน) ได้รับการยอมรับว่าเป็นบริษัทพลังงานสัญชาติไทยที่ำธุรกิจพลังงานไฟฟ้าแบบครบวงจรทั้งการผลิต จัดหา และจำหน่ายอุปกรณ์ไฟฟ้า สำหรับระบบไฟฟ้า ที่ได้มาตรฐานสากล มากกว่า 5,000 รายการ อีกทั้งยังเป็นผู้ดำเนินงานด้านวิศวกรรมไฟฟ้าที่หลากหลาย ทั้งงานก่อสร้างระบบสายส่งไฟฟ้าบนดิน ระบบสายส่งไฟฟ้าใต้ดิน และระบบเคเบิลใต้น้ำ งานก่อสร้างสถานีไฟฟ้าระบบ Microgrid และมีทีมงานที่มีความเชี่ยวชาญงานออกแบบ พร้อมแนะนำเกี่ยวกับการจัดหาอุปกรณ์ ตลอดจนงานติดตั้งระบบไฟฟ้าและพลังงานทดแทน ถือว่าเป็นบริษัทแถวหน้าที่มีความเป็นมืออาชีพในการจัดหาอุปกรณ์ รับสร้าง และบริหารโรงไฟฟ้าพลังงานทางเลือก เช่น พลังงานแสงอาทิตย์ และพลังงานลม ที่ใช้กับโรงงาน อาคารขนาดใหญ่ รวมทั้งเพื่อขายพลังงานไฟฟ้าให้กับหน่วยงานสาธารณูปโภคของรัฐ





CONTENT

GROUP A

Grounding System & Lightning Protection

TOPWELD	Lightning Protection System	A1
INTELLI / BLACKBURN	Ground Rod & Accessories	A2
TOPWELD	Grounding System & Lightning Protection	A3-A15
TOPWELD	Lightning Protection & Accessories	A16
APLICACIONES	E.S.E. Lightning Protection System	A17
TECNOLOGICAS	Surge and Overvoltage Protection Strom Detector	A18
CONDUCRETE	Conductive Conducrete For Grounding	A19

GROUP B

Cable Accessories

TOPWELD	Terminal Lug & Sleeve	B1-B6
INTELLI	Clamp and connectors	B7
TOPWELD	C-TYPE copper compression connectors	B8
RAYCHEM	Termination Kit & Splicing Kit & Accessories	B9-B18
HOMAC	Flood seal connectors	B19

GROUP C

Protective Equipments (Fuse, Switch & Surge Arrester)

GUNKUL	Dropout fuse cutout	C1
GUNKUL	Polymer Surge Arrester	C2
GUNKUL	Medium Voltage Fuse & Switch	C3
	Power Fuse	C4
	Capacitor	C5
GUNKUL	Live Part Cover & Animal Protectors	C6-C9
GUNKUL	SF6 Gas Load Break Switch	C10
SEECO	Air Break Switch & Load Break Switch	C11

GROUP D

Insulator, Cable & Hardware Accessories

	High & Low Voltage Insulator	D1-D2
	High Voltage Cables, LV, MV, HV Conductors	D3-D4
GUNKUL	Preformed Fitting	D5-D7
GUNKUL	Aluminum Connectors	D8-D10
GUNKUL	Steel Hardware & Accessories	D11-D19
HOMAC	Substation & Transmission Line Fitting	D20
GUNKUL	Supporting Structure	D21
FAVA	Telephone Test Set (Lineman test set)	D22
	Telephone Hardware & Accessories	D23-D25

GROUP E

Tools, Hydraulic Tools & Safety Tools

KEARNEY, etc.	Hot Line Tools	E1-E3
GUNKUL	Tools	E4-E6
YALE	Ratchet Lever Hoist	E7
TRADE MASTER	Pulling Grips, Support Grips	E8-E10
TRADE MASTER / KLEIN	Wire Grips	E11-E12
IZUMI	Hydraulic Tools	E13-E30

GROUP F

Measuring & Instrument

GE	Meter, Cabinet, Seal & Meter Board	F1
SENSORLINK	High Voltage Measuring Instruments	F2-F6
HD ELECTRIC	Medium Voltage Device Tester	F7-F9
THERMOVIEW	Infrared Camera	F10
ULIRVISION	Corana & Partial Discharge Detector	F11
MEGABRAS	Electrical Test & Measuring Instruments	F-12

GROUP G

Street Lighting & Accessories Sealing Compound Low Voltage Fuse System

GUNKUL	Street Lighting and Control Relays	G1-G2
GUNKUL	Street Lighting Solar cell	G3
GUNKUL	Compound and Accessories	G4
GUNKUL, KALEPORSELEN	Low Voltage Fuse	G5-G6

GROUP H

SERVICE & MAINTENANCE

DILO	F6 Service and Measuring Devices	H1-H3
SYLGARD	High Voltage Insulator Coating	H4
ALCAD	Nickel-Cadmium Industrial Batteries	H5
TEMA	Stringing Machine	H6-H7
	Oil Purifier Device	H8

GROUP I

CONDUIT FITTING, HDPE, EFLEX & CABLE GLAND

SHIMADA	Explosion Proof Electrical Fitting	I1-I8
TGG	HDPE & Eflex Conduit	I9-I10
	Conduit Fitting & Accessories	I11-I14

- * สินค้าในเล่มนี้อาจจะมีการเปลี่ยนแปลงรายละเอียดและราคาโดยไม่ต้องแจ้งให้ทราบล่วงหน้า
- ** โปรดสอบถามรายละเอียดสินค้ากับฝ่ายขายก่อนสั่งซื้อ

GROUP A

GROUNDING SYSTEM & LIGHTNING PROTECTION





Total Solution in Grounding & Lightning Protection System

Service ,Support, Sales

Supporting our customers with project consultation.

- Site surveys
- Typical Detail of installation Drawings.
- Guidance on standards
- Product Training
- Technical data documents support

GUNKUL
not only the energy, we care



@fvr7639m



g_ps2@gunkul.com

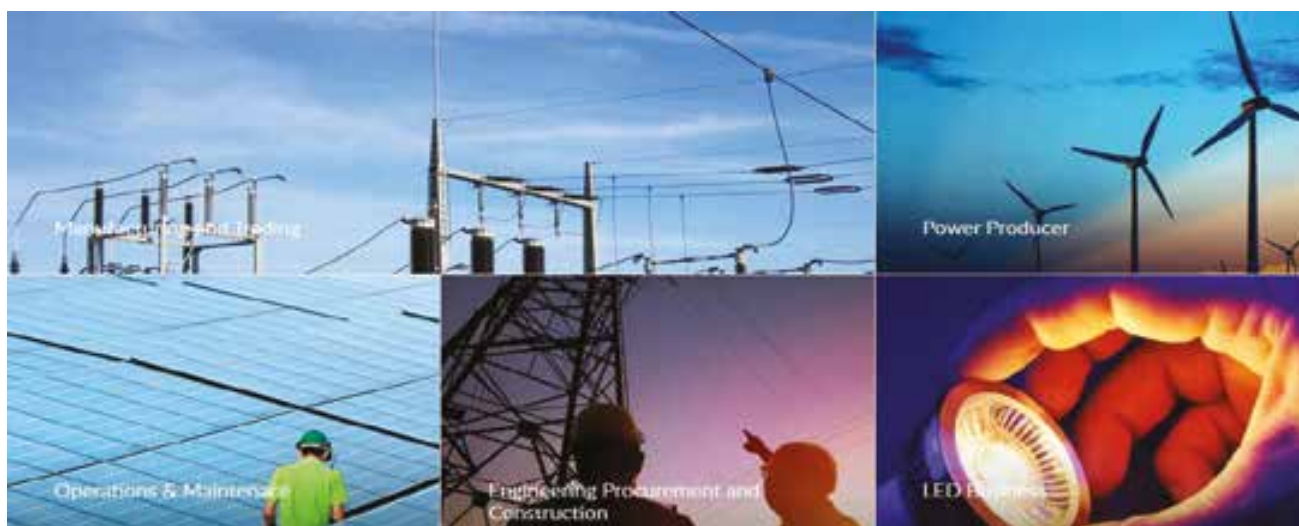

Our technical engineering team, with accumulated several knowledge of developing grounding & Lightning protection solution, we can design systems to any relevant IEC & NFPA or other recognized standard.

Additionally, active participation in the development product in accordance with international electrotechnical commission and National Fire Protection Association standards, ensure we always offer the best solution and up-to-date technical advice to global market.

So, whenever you send your requirement, technical support is readily available, from our engineers.

We believe in sharing our knowledge, so you will design and installation on the best grounding & lightning protection solution to suit your needs.



COPPER BONDED STEEL GROUND ROD

Standard Ground Rod (Single Type)

Blackburn

Cat. No.	Dia. Size inch	Actual Size mm.	Length Ft.	Price ราคา
5005	1/2	12.7	5	450.00

Standard Ground Rod (Single Type)



Cat. No.	Dia. Size inch	Actual Size mm.	Length Ft.	Price ราคา
IH-558	5/8	14.2	5	700.00
IH-658	5/8	14.2	6	760.00
IH-858	5/8	14.2	8	920.00
IH-1058	5/8	14.2	10	1,200.00
IH-1258	5/8	14.2	12	โปรดสอบถาม
IH-534	3/4	17.2	5	โปรดสอบถาม
IH-634	3/4	17.2	6	โปรดสอบถาม
IH-834	3/4	17.2	8	1,700.00
IH-1034	3/4	17.2	10	1,980.00
IH-1234	3/4	17.2	12	โปรดสอบถาม

Sectional Ground Rod (Screw Type)



Cat. No.	Dia. Size inch	Actual Size mm.	Length Ft.	Price ราคา
IHP-558	5/8	14.2	5	800.00
IHP-658	5/8	14.2	6	900.00
IHP-858	5/8	14.2	8	1,050.00
IHP-1058	5/8	14.2	10	1,300.00
IHP-1258	5/8	14.2	12	โปรดสอบถาม
IHP-534	3/4	17.2	5	โปรดสอบถาม
IHP-634	3/4	17.2	6	โปรดสอบถาม
IHP-834	3/4	17.2	8	1,750.00
IHP-1034	3/4	17.2	10	2,100.00
IHP-1234	3/4	17.2	12	โปรดสอบถาม

Couplings Ground Rod



Cat. No.	Size inch	Price ราคา
LEH-58-R	5/8	300.00
LEH-34-R	3/4	400.00

Driving Stud



Cat. No.	Size inch	Price ราคา
60 DS	5/8	250.00
70 DS	3/4	350.00

Ground Rod Clamp



Cat. No.	Size inch	Price ราคา
CAB2	5/8	100.00
CAB2	3/4	150.00
LOCAL	5/8	50.00
LOCAL	3/4	60.00

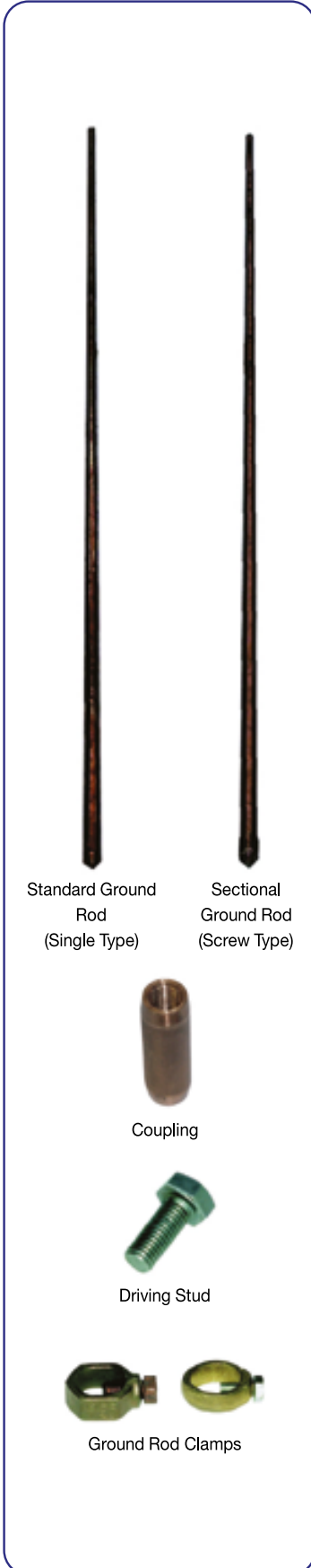

Standard Ground Rod (Single Type)







Sectional Ground Rod (Screw Type)

Coupling

Driving Stud

Ground Rod Clamps

GROUNDING SYSTEM & LIGHTNING PROTECTION

Figure	Cat No.	Description	Price
	Rod to Cable Clamp		
	T-GRC-5850	Rod dia. 5/8" (14.2 mm.), Cable size 16 - 50 sq.mm.	220.00
	T-GRC-58120	Rod dia. 5/8" (14.2 mm.), Cable size 70 - 120 sq.mm.	230.00
	T-GRC-3450	Rod dia. 3/4" (17.2 mm.), Cable size 16 - 50 sq.mm.	260.00
	Rod Parallel to Cable Clamp		
	T-GRP-172-50	Ground Rod dia. 5/8" (14.2 mm.), 3/4" (17.2 mm.), and Cable size 16 - 50 sq.mm.	750.00
	T-GRP-172-120	Rod dia. 5/8" (14.2 mm.), 3/4" (17.2 mm.), and Cable size 70 - 120 sq.mm.	900.00
	U Bolt Rod or Pipe To Tape Clamp		
	T-GUT 172-254	Ground Rod dia. 5/8" (14.2 mm.), 3/4" (17.2 mm.) and Max. Tape size 25 x 4 mm.	600.00
	Ground Clamp Connectors For Cable Connection To Rod Or Pipe		
	T-GCRP1-50	Ground Rod dia. 5/8"(14.2 mm.), 3/4" (17.2 mm.) and Cable size 16 - 50 sq.mm.	750.00
	T-GCRP1-120	Ground Rod dia. 5/8"(14.2 mm.), 3/4" (17.2 mm.) and Cable size 70 - 120 sq.mm.	800.00
	T-GCRP1-300	Ground Rod dia. 5/8"(14.2 mm.), 3/4" (17.2 mm.) and Cable size 150 - 300 sq.mm.	850.00
	T-GCRP1-231-50	Ground Rod dia. 1" (23.1 mm.) and Cable size 16-50 sq.mm.	1,000.00
	T-GCRP1-231-120	Ground Rod dia. 1"(23.1 mm.) and Cable size 70-120 sq.mm.	1,050.00
	T-GCRP1-1-120	Pipe dia. 1" (33.4 mm.), 1 1/2' (48.3 mm.) and Cable size 70 - 120 sq.mm.	1,150.00
	Ground Clamp Connectors For Two Cable Connection To Rod Or Pipe		
	T-GCRP2-50	Ground Rod dia. 5/8"(14.2 mm.), 3/4" (17.2 mm.) and Cable size 16 - 50 sq.mm.	800.00
	T-GCRP2-120	Ground Rod dia. 5/8"(14.2 mm.), 3/4" (17.2 mm.) and Cable size 70 - 120 sq.mm.	850.00
	T-GCRP2-300	Ground Rod dia. 5/8"(14.2 mm.), 3/4" (17.2 mm.) and Cable size 150 - 300 sq.mm.	900.00
	T-GCRP2-231-50	Ground Rod dia. 1" (23.1 mm.) and Cable size 16-50 sq.mm.	1,200.00
	T-GCRP2-231-120	Ground Rod dia. 1"(23.1 mm.) and Cable size 70-120 sq.mm.	1,250.00
	T-GCRP2-1-120	Pipe dia. 1" (33.4 mm.), 1 1/2' (48.3 mm.) and Cable size 70 - 120 sq.mm.	1,500.00
	T-GCRP2-1-300	Pipe dia. 1" (33.4 mm.), 1 1/2' (48.3 mm.) and Cable size 150 - 300 sq.mm.	1,550.00
	Ground Clamp Connectors For Three Cable Connection To Rod Or Pipe		
	T-GCRP3-50	Ground Rod dia. 5/8"(14.2 mm.), 3/4" (17.2 mm.) and Cable size 16 - 50 sq.mm.	1,000.00
	T-GCRP3-120	Ground Rod dia. 5/8"(14.2 mm.), 3/4" (17.2 mm.) and Cable size 70 - 120 sq.mm.	1,050.00
	T-GCRP3-300	Ground Rod dia. 5/8"(14.2 mm.), 3/4" (17.2 mm.) and Cable size 150 - 300 sq.mm.	1,150.00
	T-GCRP3-231-50	Ground Rod dia. 1" (23.1 mm.) and Cable size 16-50 sq.mm.	1,300.00
	T-GCRP3-231-120	Ground Rod dia. 1"(23.1 mm.) and Cable size 70-120 sq.mm.	1,350.00
	T-GCRP3-1-120	Pipe dia. 1" (33.4 mm.), 1 1/2' (48.3 mm.) and Cable size 70 - 120 sq.mm.	1,600.00
	T-GCRP3-1-300	Pipe dia. 1" (33.4 mm.), 1 1/2' (48.3 mm.) and Cable size 150 - 300 sq.mm.	1,700.00

GROUNDING SYSTEM & LIGHTNING PROTECTION

Figure	Cat No.	Description	Price
	One Hole Cable Grip		
	T-GOCG 35	Cable size 25 - 35 sq.mm.	45.00
	T-GOCG 70	Cable size 50 - 70 sq.mm.	50.00
	T-GOCG 120	Cable size 95 - 120 sq.mm.	65.00
	T-GOCG 185	Cable size 150 - 185 sq.mm.	220.00
	T-GOCG 300	Cable size 240 - 300 sq.mm.	280.00
	Ground Clamp		
	T-GC 50-70	Cable size 50 - 70 sq.mm.	60.00
	T-GC 95-120	Cable size 95 - 120 sq.mm.	65.00
	T-GC 150-185	Cable size 150 - 185 sq.mm.	280.00
	Ground Clamp Bonding For Cable To Flat Surface		
	T-GMS 2	Cable size 25 - 50 sq.mm.	330.00
	T-GMS 3	Cable size 70 - 120 sq.mm.	460.00
	T-GMS 4	Cable size 150 - 240 sq.mm.	700.00
	Ground Clamp Bonding For Cable To Flat Surface		
	T-GM 2	Cable size 25 - 50 sq.mm.	460.00
	T-GM 3	Cable size 70 - 120 sq.mm.	600.00
	T-GM 4	Cable size 150 - 240 sq.mm.	900.00
	Ground Clamp Bonding For Two Cable to Flat Surface		
	T-GHS 2	Cable size 25 - 50 sq.mm.	420.00
	T-GHS 3	Cable size 70 - 120 sq.mm.	560.00
	T-GHS 4	Cable size 150 - 240 sq.mm.	800.00
	Ground Clamp Bonding For Two Cable to Flat Surface		
	T-GH 2	Cable size 25 - 50 sq.mm.	560.00
	T-GH 3	Cable size 70 - 120 sq.mm.	840.00
	T-GH 4	Cable size 150 - 240 sq.mm.	1,100.00
	Earth Boss		
	T-GEB	Stainless Earth Boss dia. 50 mm., Length 45 mm.	740.00
	Beam Clamp		
	T-GBC 35-120	Cable size 35 - 120 sq.mm.	900.00
	Earth Point		
	T-GEP1	Earth Point 1 Hole	500.00
	T-GEP2	Earth Point 2 Holes	800.00
	T-GEP4	Earth Point 4 Holes	1,000.00
	Earth Point Tail Type		
	T-GEPT1-70-500	1 Hole, Cable size 70 sq.mm. and Cable Length 500 mm.	On Request
	T-GEPT2-70-500	2 Holes, Cable size 70 sq.mm. and Cable Length 500 mm.	On Request
	T-GEPT2-70-1000	2 Holes, Cable size 70 sq.mm. and Cable Length 1000 mm.	On Request
	T-GEPT4-70-500	4 Holes, Cable size 70 sq.mm. and Cable Length 500 mm.	On Request
	T-GEPT4-70-1000	4 Holes, Cable size 70 sq.mm. and Cable Length 1000 mm.	On Request
	* Other size is also available upon request		
	Conductor to Rebar Clamp		
	T-GCTRC	Cable Size 16-70 sq.mm., DB 8-18 mm.	820.00



GROUNDING SYSTEM & LIGHTNING PROTECTION

Figure	Cat No.	Description	Price
	PVC Test Box		
	T-GPVCTB	PVC Test Box size L.200 x W.150 x H.100 mm.	1,800.00
	Aluminium Test Box		
	T-GATB	Aluminium Test Box size L.260 x W.163 x H.77 mm.	2,300.00
	Concrete Inspection Pit		
	T-GCIPB	Concrete Pit size L.330 x W.330 x H.254 mm. * Other size is also available upon request	1,500.00
	Ground Bar Pit (with fin)		
	T-GBP-5	Bar Pit Size L.315 x W.50.8 x T.6.35 mm. Ø Hole M10 , 5 Hole	900.00
	T-GBP-7	Bar Pit Size L.315 x W.50.8 x T.6.35 mm. Ø Hole M10 , 7 Hole	900.00
	Disconnecting Link		
	T-GDL-253	Disconnecting Link size L.200 X W.50 X H.90 mm.	1,000.00
	Ground Bar		
	T-GB-6	Dimension L.355.6 X W.50.8 X H.71.75 mm., No. of Hole 6	3,500.00
	T-GB-8	Dimension L.455 X W.50.8 X H.71.75 mm., No. of Hole 8	3,900.00
	T-GB-12	Dimension L.660 X W.50.8 X H.71.75 mm., No. of Hole 12	4,950.00
	Ground Bar		
	T-GB-6D	Dimension L.355.6 X W.101.6 X H.74.9 mm., No. of Hole 12	5,900.00
	T-GB-8D	Dimension L.457 X W.101.6 X H.74.9 mm., No. of Hole 16	6,900.00
	T-GB-12D	Dimension L.760 X W.101.6 X H.74.9 mm., No. of Hole 24	12,000.00
	Power Ground Station		
	T-GSPS-6	Dimension Bar 50.8 x 350 x 6.35 mm., No. of Hole 6	1,300.00
	T-GSPS-8	Dimension Bar 50.8 x 440 x 6.35 mm., No. of Hole 8	1,850.00
	T-GSPS-12	Dimension Bar 50.8 x 610 x 6.35 mm., No. of Hole 12	2,300.00
	T-GSPS-6D	Dimension Bar 101.6 x 350 x 6.35 mm., No. of Hole 12	2,550.00
	T-GSPS-8D	Dimension Bar 101.6 x 440 x 6.35 mm., No. of Hole 16	3,350.00
	T-GSPS-12D	Dimension Bar 101.6 x 610 x 6.35 mm., No. of Hole 24	4,200.00
	Communication Ground Station		
	T-GSCS-200	Dimension Bar 101.6 x 200 x 6.35 mm., No. of Hole 6	1,400.00
	T-GSCS-300	Dimension Bar 101.6 x 300 x 6.35 mm., No. of Hole 11	2,200.00
	T-GSCS-400	Dimension Bar 101.6 x 400 x 6.35 mm., No. of Hole 15	2,900.00
	T-GSCS-450	Dimension Bar 101.6 x 450 x 6.35 mm., No. of Hole 18	3,000.00
	T-GSCS-600	Dimension Bar 101.6 x 600 x 6.35 mm., No. of Hole 24	4,250.00
	Tin Plated Copper Flexible Braid Bond (1 Hole)		
	T-LFB1-35300	Cross Section 35 sq.mm., Length 300 mm., Amp Rating 200 A	900.00
	T-LFB1-50300	Cross Section 50 sq.mm., Length 300 mm., Amp Rating 250 A * Other size is also available upon request	1,100.00
	Tin Plated Copper Flexible Braid Bond (2 Hole)		
	T-LFB2-150386	Cross Section 150 sq.mm., Length 386 x Width.31.8 mm. , 3 Layer, Coss Section 150 sq.mm., Amp Rating 700 A	4,000.00

GROUNDING SYSTEM & LIGHTNING PROTECTION

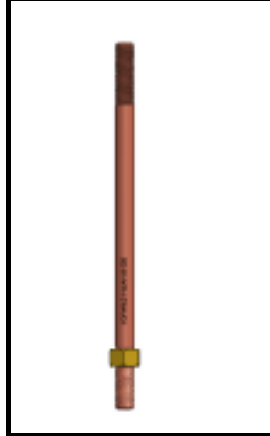

Cat No.	Description	Price
Lightning Pole (Pole Tapered with HDG.)		
T-LPT-3000-70	Height 3 M. with copper conductor 70 sq.mm.	On Request
T-LPT-6000-70	Height 6 M. with copper conductor 70 sq.mm.	On Request
T-LPT-9000-70	Height 9 M. with copper conductor 70 sq.mm.	On Request
T-LPT-12000-70	Height 12 M. with copper conductor 70 sq.mm.	On Request
T-LPT-15000-70	Height 15 M. with copper conductor 70 sq.mm.	On Request
	* Other size is also available upon request	
Lightning Pole (Straight Pipe with HDG.)		
T-LPS-2000-70	Height 2 M. with copper conductor 70 sq.mm.	On Request
T-LPS-3000-70	Height 3 M. with copper conductor 70 sq.mm.	On Request
T-LPS-5000-70	Height 5 M. with copper conductor 70 sq.mm.	On Request
T-LPS-6000-70	Height 6 M. with copper conductor 70 sq.mm.	On Request
T-LPS-9000-70	Height 9 M. with copper conductor 70 sq.mm.	On Request
T-LPS-12000-70	Height 12 M. with copper conductor 70 sq.mm.	On Request
T-LPS-15000-70	Height 15 M. with copper conductor 70 sq.mm.	On Request
	* Other size is also available upon request	
Multi Point Air Terminal		
T-LMPAT 58	Multi Point dia. 5/8"	630.00
T-LMPAT 34	Multi Point dia. 3/4"	630.00
Elevation Air Terminal		
T-LEAT-58-300	Air Terminal dia. 15 mm. (5/8"), Length 300 mm.	560.00
T-LEAT-58-500	Air Terminal dia. 15 mm. (5/8"), Length 500 mm.	860.00
T-LEAT-58-600	Air Terminal dia. 15 mm. (5/8"), Length 600 mm.	1,030.00
T-LEAT-58-1000	Air Terminal dia. 15 mm. (5/8"), Length 1,000 mm.	1,650.00
T-LEAT-58-1500	Air Terminal dia. 15 mm. (5/8"), Length 1,500 mm.	2,340.00
T-LEAT-58-2000	Air Terminal dia. 15 mm. (5/8"), Length 2,000 mm.	3,290.00
T-LEAT-34-300	Air Terminal dia. 19 mm. (3/4"), Length 300 mm.	800.00
T-LEAT-34-500	Air Terminal dia. 19 mm. (3/4"), Length 500 mm.	1,230.00
T-LEAT-34-600	Air Terminal dia. 19 mm. (3/4"), Length 600 mm.	1,500.00
T-LEAT-34-1000	Air Terminal dia. 19 mm. (3/4"), Length 1,000 mm.	2,370.00
T-LEAT-34-1500	Air Terminal dia. 19 mm. (3/4"), Length 1,500 mm.	3,270.00
T-LEAT-34-2000	Air Terminal dia. 19 mm. (3/4"), Length 2,000 mm.	4,420.00
Air Terminal (Copper)		
T-LBAT-58-300	Air Terminal dia. 15 mm. (5/8"), Length 300 mm.	560.00
T-LBAT-58-500	Air Terminal dia. 15 mm. (5/8"), Length 500 mm.	860.00
T-LBAT-58-600	Air Terminal dia. 15 mm. (5/8"), Length 600 mm.	1,030.00
T-LBAT-58-1000	Air Terminal dia. 15 mm. (5/8"), Length 1,000 mm.	1,650.00
T-LBAT-58-1500	Air Terminal dia. 15 mm. (5/8"), Length 1,500 mm.	2,340.00
T-LBAT-58-2000	Air Terminal dia. 15 mm. (5/8"), Length 2,000 mm.	3,290.00
T-LBAT-34-300	Air Terminal dia. 19 mm. (3/4"), Length 300 mm.	800.00
T-LBAT-34-500	Air Terminal dia. 19 mm. (3/4"), Length 500 mm.	1,230.00
T-LBAT-34-600	Air Terminal dia. 19 mm. (3/4"), Length 600 mm.	1,500.00
T-LBAT-34-1000	Air Terminal dia. 19 mm. (3/4"), Length 1,000 mm.	2,370.00
T-LBAT-34-1500	Air Terminal dia. 19 mm. (3/4"), Length 1,500 mm.	3,270.00
T-LBAT-34-2000	Air Terminal dia. 19 mm. (3/4"), Length 2,000 mm.	4,420.00



GROUNDING SYSTEM & LIGHTNING PROTECTION

Figure	Cat No.	Description	Price
	Air Terminal (Aluminium)		
	T-LBAT-58-300A	Air Terminal dia. 15 mm. (5/8"), Length 300 mm.	410.00
	T-LBAT-58-500A	Air Terminal dia. 15 mm. (5/8"), Length 500 mm.	630.00
	T-LBAT-58-600A	Air Terminal dia. 15 mm. (5/8"), Length 600 mm.	750.00
	T-LBAT-58-1000A	Air Terminal dia. 15 mm. (5/8"), Length 1,000 mm.	1,220.00
	T-LBAT-58-1500A	Air Terminal dia. 15 mm. (5/8"), Length 1,500 mm.	1,710.00
	T-LBAT-58-2000A	Air Terminal dia. 15 mm. (5/8"), Length 2,000 mm.	2,430.00
	T-LBAT-34-300A	Air Terminal dia. 19 mm. (3/4"), Length 300 mm.	580.00
	T-LBAT-34-500A	Air Terminal dia. 19 mm. (3/4"), Length 500 mm.	900.00
	T-LBAT-34-600A	Air Terminal dia. 19 mm. (3/4"), Length 600 mm.	1,100.00
	T-LBAT-34-1000A	Air Terminal dia. 19 mm. (3/4"), Length 1,000 mm.	1,740.00
	T-LBAT-34-1500A	Air Terminal dia. 19 mm. (3/4"), Length 1,500 mm.	2,400.00
	T-LBAT-34-2000A	Air Terminal dia. 19 mm. (3/4"), Length 2,000 mm.	3,230.00
	Adjustable Saddle Aluminum For Tape		
	T-LAST 58-253A	Thread size 15 mm. (5/8"), Aluminum Tape size 25 x 3 mm.	810.00
	T-LAST 58-254A	Thread size 15 mm. (5/8"), Aluminum Tape size 25 x 4 mm.	820.00
	T-LAST 34-254A	Thread size 19 mm. (3/4"), Aluminium Tape size 25 x 4 mm.	840.00
	Aluminum For Cable		
	T-LASC 58A	Thread size 15 mm. (5/8"), Cable size 50 - 70 sq.mm.	800.00
	Tape Saddle Aluminum		
	T-LTS 58A	Thread size 15 mm. (5/8"), Aluminum Tape size 25 x 4 mm.	480.00
	T-LTS 34A	Thread size 19 mm. (3/4"), Aluminium Tape size 25 x 4 mm.	500.00
	Tape Saddle		
	T-LTS 58	Thread size 15 mm. (5/8"), Copper Tape size 25 x 3 mm.	570.00
	T-LTS 34	Thread size 19 mm. (3/4"), Copper Tape size 25 x 3 mm.	590.00
	Flat Saddle		
	T-LFS-58	Thread size 15 mm. (5/8"), Tape 25x3 mm., Cable 25-120 sq.mm.	680.00
	T-LFS-34	Thread size 19 mm. (3/4"), Tape 25x3 mm., Cable 25-120 sq.mm.	700.00
	Ridge Saddle		
	T-LRDS-58	Thread size 15 mm. (5/8"), Tape 25x3 mm., Cable 25-120 sq.mm.	870.00
	T-LRDS-34	Thread size 19 mm. (3/4"), Tape 25x3 mm., Cable 25-120 sq.mm.	890.00
	Round Saddle		
	T-LRS 58-70	Thread size 15 mm. (5/8"), Cable size 50 - 70 sq.mm.	830.00
	T-LRS 58-120	Thread size 15 mm. (5/8"), Cable size 95 - 120 sq.mm.	880.00
	T-LRS 34-70	Thread size 19 mm. (3/4"), Cable size 50 - 70 sq.mm.	860.00
	T-LRS 34-120	Thread size 19 mm. (3/4"), Cable size 95 - 120 sq.mm.	900.00
	Floor Saddle		
	T-LFRS 58	Thread size 15 mm. (5/8"), Cable size 50 - 120 sq.mm.	750.00
	T-LFRS 34	Thread size 19 mm. (3/4"), Cable size 50 - 120 sq.mm.	780.00
	Cross Cable Saddle		
	T-LCCS 58	Thread size 15 mm. (5/8"), Cable size 50 - 120 sq.mm.	850.00
	T-LCCS 34	Thread size 19 mm. (3/4"), Cable size 50 - 120 sq.mm.	890.00

GROUNDING SYSTEM & LIGHTNING PROTECTION

Figure	Cat No.	Description	Price
	Adjustable Saddle		
	For Cable		
	T-LASC 58	Thread size 15 mm. (5/8"), Cable size 50 - 70 sq.mm.	1,000.00
	T-LASC 58-120	Thread size 15 mm. (5/8"), Cable size 95 - 120 sq.mm.	1,100.00
	T-LASC 34	Thread size 19 mm. (3/4"), Cable size 50 - 70 sq.mm.	1,250.00
T-LASC 34-120	Thread size 19 mm. (3/4"), Cable size 95 - 120 sq.mm.	1,320.00	
	For Tape		
	T-LAST 58-253	Thread size 15 mm. (5/8"), Copper Tape size 25 x 3 mm.	1,100.00
	T-LAST 34-253	Thread size 19 mm. (3/4"), Copper Tape size 25 x 3 mm.	1,150.00
	Wall Saddle		
	T-LWS 58	Thread size 15 mm. (5/8"), Cable size 50 - 120 sq.mm.	750.00
T-LWS 34	Thread size 19 mm. (3/4"), Cable size 50 - 120 sq.mm.	780.00	
	Steel Plate For Saddle		
	T-LSPS-BS525	Steel Plate with Stainless Steel Bolt JP size M5x25 mm. For Saddle	740.00
	Stainless Steel Bolt For Support		
	T-BS26	Stainless Steel Bolt Taper Head size 1/4" x 3/4"	10.00
	T-BS525	Stainless Steel Bolt JP size M5x25 mm.	4.00
	T-BS5	Stainless Steel Flange Nut	8.00
	Terminal Lug, Socket Type		
	T-GTL 35	Cable size 16 - 35 sq.mm.	90.00
	T-GTL 70	Cable size 50 - 70 sq.mm.	110.00
	T-GTL 120	Cable size 95 - 120 sq.mm.	250.00
	T-GTL 185	Cable size 150 - 185 sq.mm.	320.00
	T-GTL 300	Cable size 240 - 300 sq.mm.	400.00
	Clamp Connector Screw Type		
	T-GCST 35	Cable run size 16 - 35 sq.mm., and Tap 6 - 35 sq.mm.	70.00
	T-GCST 70	Cable run size 50 - 70 sq.mm., and Tap 6 - 70 sq.mm.	100.00
	T-GCST 120	Cable run size 95 - 120 sq.mm., and Tap 6 - 120 sq.mm.	150.00
	T-GCST 185	Cable run size 150 - 185 sq.mm., and Tap 6 - 185 sq.mm.	270.00
	T-GCST 300	Cable run size 240 - 300 sq.mm., and Tap 6 - 300 sq.mm.	380.00



GROUNDING SYSTEM & LIGHTNING PROTECTION

Figure	Cat No.	Description	Price	
	Cable Saddle			
	T-LCS 35	Cable size 25 - 35 sq.mm.	85.00	
	T-LCS 70	Cable size 50 - 70 sq.mm.	95.00	
	T-LCS 120	Cable size 95 - 120 sq.mm.	120.00	
	T-LCS 185	Cable size 150 - 185 sq.mm.	170.00	
	T-LCS 300	Cable size 240 - 300 sq.mm.	230.00	
	Aluminium			
T-LCS 70A	Cable size 50 - 70 sq.mm., Aluminium	80.00		
	Cable Cross Clamp			
	T-LCCC 35-70	Cable size 35 - 70 sq.mm.	530.00	
	T-LCCC 95-120	Cable size 95-120 sq.mm.	690.00	
	Aluminium			
T-LCCC 35-70A	Cable size 35 - 70 sq.mm., Aluminium	400.00		
	Tee Clamp			
	T-LTC 70	Cable size 50 - 70 sq.mm.	270.00	
	T-LTC 120	Cable size 95 - 120 sq.mm.	330.00	
	Aluminium			
T-LTC 70A	Cable size 50 - 70 sq.mm., Aluminium	220.00		
	Cable Test Connector			
	T-LCTC 35-120	Cable size 35 - 120 sq.mm.	500.00	
	Bi-Metallic Connector			
	T-LBMC	Connector Copper and Aluminium	1,000.00	
	T-LBWC 12	Bimetallic Washer M12	250.00	
	Cable-Tape Test Connector			
	T-LCTT 70-253	Cable size 70 sq.mm., Copper Tape size 25 x 3 mm.	500.00	
	T-LCTT 95-253	Cable size 95 sq.mm., Copper Tape size 25 x 3 mm.	540.00	
	T-LCTT 120-253	Cable size 120 sq.mm., Copper Tape size 25 x 3 mm.	690.00	
	Aluminium			
T-LCTT 70-253A	Cable size 70 sq.mm., Aluminium Tape size 25 x 3 mm.	400.00		
	Cable to Tape Clamp			
	T-LCTC 120-253	Cable size 35-120 sq.mm., Copper Tape size 25x3 mm.	550.00	
	Aluminium			
T-LCTC 120-253A	Cable size 35-120 sq.mm., Aluminium Tape size 25x3 mm.	360.00		
	Tape Test Connector			
	T-LTTC 256	Maximum Copper Tape size 26 x 8 mm.	400.00	
	Aluminium			
	T-LTTC 256A	Maximum Aluminium Tape size 26 x 8 mm.	360.00	

GROUNDING SYSTEM & LIGHTNING PROTECTION

	Tape Clip		
	T-LTC 253	Copper Tape size 25 x 3 mm.	40.00
	T-LTC 254	Copper Tape size 25 x 4 mm.	50.00
	T-LTC 304	Copper Tape size 30 x 4 mm.	60.00
	T-LTC 506	Copper Tape size 50 x 6 mm.	90.00
	Tape Support		
	T-LTS 253	Copper Tape size 25 x 3 mm.	80.00
	T-LTS 324	Copper Tape size 32 x 4 mm.	180.00
	T-LTS 505	Copper Tape size 50 x 5 mm.	250.00
	Aluminium		
	T-LTS 253A	Aluminium Tape size 25 x 3 mm.	60.00
	T-LTS 254A	Aluminium Tape size 25 x 4 mm.	65.00
	Square Tape Support		
	T-LSTS 253	Copper Tape size 25 x 3 mm.	310.00
	T-LSTS 324	Copper Tape size 32 x 4 mm.	550.00
	T-LSTS 505	Copper Tape size 50 x 5 mm.	600.00
	Aluminium		
	T-LSTS 253A	Aluminium Tape size 25 x 3 mm.	240.00
	T-LSTS 254A	Aluminium Tape size 25 x 4 mm.	250.00
	Ground Wire Support		
	T-LGWS 35-120	For Cable size 35 - 120 sq.mm.	130.00
	T-LGWS 253	For Copper Tape size 25 x 3 mm.	170.00
	Supporting (Porcelain)		
	T-LSP	White Color	60.00
	Support (Bakelite)		
	T-LSB	Black Color	30.00
	Metal Sheet Clamp		
	T-LMSC-1S	Stainless Steel	110.00
	T-LMSC-2S	Stainless Steel	110.00
	T-LMSC-3S	Stainless Steel	60.00
	T-LMSC-4S	Stainless Steel	110.00
	Roof Holders		
	For Hip or Ridge Tiles		
	T-LRHHR-100S	Stainless Steel	450.00
	T-LRHHR-200S	Stainless Steel	450.00
	T-LRHHR-600S	Stainless Steel (PEA Specification)	900.00
For Tile Sheet			
T-LRTHS-205SF	Stainless Steel	330.00	
T-LRTHS-405SF	Stainless Steel	360.00	



GROUNDING SYSTEM & LIGHTNING PROTECTION

	Tape Conductors : Copper Tape		
	T-LCT 253	Copper Tape size 25 x 3 mm. (75 sq.mm.)	On Request
	T-LCT 254	Copper Tape size 25 x 4 mm. (100 sq.mm.)	On Request
	T-LCT 324	Copper Tape size 32 x 4 mm. (128 sq.mm.)	On Request
	Tape Conductors : Tinned Copper Tape		
	T-LTCT 253	Tin Copper Tape size 25 x 3 mm. (75 sq.mm.)	On Request
	T-LTCT 254	Tin Copper Tape size 25 x 4 mm. (100 sq.mm.)	On Request
	Tape Conductors : Aluminium Tape		
	T-LAT 253	Aluminium Tape size 25 x 3 mm. (75 sq.mm.)	On Request
	T-LAT 254	Aluminium Tape size 25 x 4 mm. (100 sq.mm.)	On Request
	Tape Conductors : PVC Covered Copper Tape		
	T-LCT 253P	PVC Covered Copper Tape size 25 x 3 mm.	On Request
	T-LCT 254P	PVC Covered Copper Tape size 25 x 4 mm.	On Request
	Tape Conductors : PVC Covered Aluminium Tape		
	T-LAT 253P	PVC Covered Aluminium Tape size 25 x 3 mm.	On Request
	T-LAT 254P	PVC Covered Aluminium Tape size 25 x 4 mm.	On Request
	Circular Conductors : Solid Copper		
	T-CC-10	Solid Copper Conductors dia. 10 mm.	On Request
	Copper Claded Steel Wire (Single Core)		
	T-2AWG	Conductors 2 AWG. (33.62 sq.mm.)	On Request
	T-ACCS-50	Conductors Dia. 8 mm. (50 sq.mm.)	On Request
	T-ACCS-70	Conductors Dia 10 mm. (78 sq.mm.)	On Request
	Copper Claded Steel Wire (Single Core)		
	T-ACBS-10	Conductor Dia. 10 mm.	On Request
	Hard Draw Bus Bar		
	T-HDBB304	Bus Bar size W. 30 mm. x T. 4 mm. , Length 5 M.	On Request
	T-HDBB324	Bus Bar size W. 32 mm. x T. 4 mm. , Length 5 M.	On Request
	T-HDBB305	Bus Bar size W. 30 mm. x T. 5 mm. , Length 5 M.	On Request
	T-HDBB325	Bus Bar size W. 32 mm. x T. 5 mm. , Length 5 M.	On Request
	T-HDBB405	Bus Bar size W. 40 mm. x T. 5 mm. , Length 5 M.	On Request
	T-HDBB505	Bus Bar size W. 50 mm. x T. 5 mm. , Length 5 M.	On Request

GROUNDING SYSTEM & LIGHTNING PROTECTION



Graphite Mould For Cable, Rod, Bus Bar, Rebar, Steel, Pipe		
T4	Graphite Mould Type " 4 "	4,600.00
T5	Graphite Mould Type " 5 "	9,700.00
T6	Graphite Mould Type " 6 "	7,700.00

Weld Metal Powder For Cable, Rod, Bus Bar, Rebar, Steel, Pipe		
15 S	Weld Metal Powder size 15 g.	120.00
25 S	Weld Metal Powder size 25 g.	130.00
32 S	Weld Metal Powder size 32 g.	140.00
45 S	Weld Metal Powder size 45 g.	175.00
65 S	Weld Metal Powder size 65 g.	200.00
90 S	Weld Metal Powder size 90 g.	220.00
115 S	Weld Metal Powder size 115 g.	275.00
150 S	Weld Metal Powder size 150 g.	345.00
200 S	Weld Metal Powder size 200 g.	425.00
250 S	Weld Metal Powder size 250 g.	495.00
500 S	Weld Metal Powder size 500 g.	940.00



Handle Clamp For Mould		
MC 4	Handle Clamp Type " 4 "	3,100.00
MC 5	Handle Clamp Type " 5 "	3,500.00











Handle Clamp With Support		
MC4-A 3657	Handle Clamp Type "4" with Vertical Beam Support	5,300.00
MC5-A 3657	Handle Clamp Type "5" with Vertical Beam Support	5,700.00
MC4-A 3658	Handle Clamp Type "4" with Chain Support	5,100.00
MC5-A 3658	Handle Clamp Type "5" with Chain Support	5,500.00
A 3657	Vertical Beam Support	2,200.00



Tool and Accessories For Exothermic Welding		
T-A 300	Tool and Accessories (Sets) (Tool Box, Wire Cleaning Brush, Flint Gun, Mold Cleaning Brush, Slag Removal Scrapper , Butane Gas , Butane Torch)	6,980.00
A 302	Tool Box	3,800.00
A 305	Wire Cleaning Brush	750.00
A 309	Flint Gun	500.00
A 310	Mold Cleaning Brush	400.00
A 311	Slag Removal Scrapper	150.00
A 312	Butane Gas	180.00
A 313	Butane Torch	1,200.00

ONE-TIME

GROUNDING SYSTEM & LIGHTNING PROTECTION

	One Time Type CC1 : Cable End To End		
	CC1 - Series	Cable Size 16 - 35 sq.mm.	250.00
		Cable Size 50 - 70 sq.mm.	280.00
		Cable Size 95 - 120 sq.mm.	280.00
Cable Size 150 - 300 sq.mm.		750.00	
	One Time Type CC2 : Cable Run & Tap		
	CC2 - Series	Cable Size 16 - 35 sq.mm.	260.00
		Cable Size 50 - 70 sq.mm.	290.00
		Cable Size 95 - 120 sq.mm.	290.00
Cable Size 150 - 300 sq.mm.		800.00	
	One Time Type CC4 : Cable Cross		
	CC4 - Series	Cable Size 16 - 35 sq.mm.	280.00
		Cable Size 50 - 70 sq.mm.	300.00
		Cable Size 95 - 120 sq.mm.	850.00
Cable Size 150 - 300 sq.mm.		850.00	
	One Time Type GR1 : Cable To Rod		
	GR1 - Series	Cable Size 16 - 35 sq.mm., with Rod Size 5/8", 3/4"	250.00
		Cable Size 50 - 70 sq.mm., with Rod Size 5/8", 3/4"	280.00
		Cable Size 95 - 120 sq.mm., with Rod Size 5/8", 3/4"	280.00
Cable Size 150 - 300 sq.mm., with Rod Size 5/8", 3/4"		750.00	
	One Time Type GT2 : Cable Horizontal to Rod		
	GT2 - Series	Cable Size 16 - 35 sq.mm., with Rod Size 5/8", 3/4"	260.00
		Cable Size 50 - 70 sq.mm., with Rod Size 5/8", 3/4"	290.00
		Cable Size 95 - 120 sq.mm., with Rod Size 5/8", 3/4"	290.00
Cable Size 150 - 300 sq.mm., with Rod Size 5/8", 3/4"		800.00	
	One Time Type NT3 : Cable Run & Tap To Rod		
	NT3 - Series	Cable Size 16 - 35 sq.mm., with Rod Size 5/8", 3/4"	280.00
		Cable Size 50 - 70 sq.mm., with Rod Size 5/8", 3/4"	300.00
		Cable Size 95 sq.mm., with Rod Size 5/8", 3/4"	300.00
Cable Size 120 - 300 sq.mm., with Rod Size 5/8", 3/4"		850.00	
	One Time Type XT4 : Cable Cross To Rod		
	XT4 - Series	Cable Size 16 - 35 sq.mm., with Rod Size 5/8", 3/4"	300.00
		Cable Size 50 - 70 sq.mm., with Rod Size 5/8", 3/4"	350.00
		Cable Size 95 - 120 sq.mm., with Rod Size 5/8", 3/4"	900.00
Cable Size 150 - 300 sq.mm., with Rod Size 5/8", 3/4"		900.00	
	One Time Type CB1 : Cable To Bar		
	CB1 - Series	Cable Size 16 - 35 sq.mm.	250.00
		Cable Size 50 - 70 sq.mm.	280.00
		Cable Size 95 - 120 sq.mm.	280.00
Cable Size 150 - 300 sq.mm.		750.00	

ONE-TIME ELECTRICAL CONNECTIONS

วิธีเชื่อมต่อกราวด์หลอด

1. ชิ้นส่วนต่างๆทั้งหมด ได้ถูกบรรจุอยู่ในแบบหล่อ ซีลยางถูกบรรจุในส่วนด้านล่างสุดของแบบหล่อ เพื่อป้องกันการรั่วไหล
2. สอดสายไฟลงในสลีฟ และวางแท่งกราวด์หลอด
3. เทผงเชื่อมลงในเบ้า OneTime เตรียมเชื่อมโลหะในแม่พิมพ์
4. ปิดฝาเคาะผงที่ค้างกัน ตรงปากทางนำร่องจุดชนวนระเบิดโดยใช้ปืนสำหรับจุดเท่านั้น
5. เสร็จสิ้นการเชื่อมต่อสายแบบหล่อของ OneTime

คำเตือน: ก่อนที่จะทำการเชื่อมต่อทุกครั้ง เพื่อความปลอดภัยควรอ่านรายละเอียดข้อควรระวังและวิธีการทำงานตามขั้นตอนคำแนะนำตามคู่มือในกล่อง OneTime โดยผู้ชำนาญการ

ข้อควรระวัง !! ห้ามเก็บไว้ในที่เปียกชื้น, ระวังแตก



1
All parts packed
In Mold.,Rubber
Seal in mold bottom
Prevents leaking.



2
Insert Cable in
Sleeve and
Place Rod.

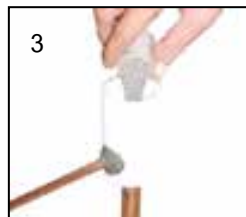

3
Dump OneTime
Weld metal in mold.



4
Ignite with flint gun.



5
Finished OneTime
Connection.

Prior to marking a connection.,the detailed instructions and safety precautions provide with each OneTime Mold should be read.



GROUNDING SYSTEM & LIGHTNING PROTECTION

	Earthing Spike (การวางหรือตีสี่แนก)	
	GKA-ETS-2000	Earthing Spike Size 60 x 60 x 5 x 2000 mm. (Material : Mild Steel) Hot Dip Galvanied Not Less Than 85 Microns.
	850.00	
	<p>Type of Exothermic Welding</p> <p style="text-align: right;">CG 98</p> <p style="text-align: right;">CG 99</p> <p style="text-align: right;">CG 66</p>	

LIGHTNING PROTECTION & ACCESSORIES



Flexible Tin Braid



Copper Wire



Earth Terminal

Flexible Tin Braid

แฟล็กซีเบิลทินเบรค

Size				Price ราคา
sq.mm	Width mm.	Thick mm.	Length per roll (m)	
5	12	1.5	100	90.00
10	15	1.5	100	140.00
16	20	2	100	285.00
25	25	2	100	390.00
35	25	2.4	100	500.00
50	30	3.5	100	750.00
100	40	5	50	1,500.00

Copper Steel Wire 30% conductivity

คอปเปอร์สตีลไวร์



Cat. No.	Size	Price / Meter ราคา / เมตร
CS2AWG	2 AWG	200.00

* Other size is also available upon request

Earth Terminal Stainless Steel - SUS304

Cat. No.	Material (Body)	Galvanized Steel Conductor Size	Thread Size
T-GETS-M8-150	Stainless Steel	Ø 8 mm. x Length 150	M8
T-GETS-M8-400	Stainless Steel	Ø 8 mm. x Length 400	M8
T-GETS-M8-600	Stainless Steel	Ø 8 mm. x Length 600	M8
T-GETS-M10-150	Stainless Steel	Ø10 mm. x Length 150	M10
T-GETS-M10-400	Stainless Steel	Ø10 mm. x Length 400	M10
T-GETS-M10-600	Stainless Steel	Ø10 mm. x Length 600	M10

** On Request

**E.S.E. LIGHTNING PROTECTION SYSTEM
EARLY STREAMER EMISSION AIR TERMINAL**



Protection radii according to standards
UNE 21186 and NF C 17-102



SPECIFICATIONS :

Early Streamer Emission Air Terminal (ESEAT), Pulsating emission lightning conductor, ION-CORONA DAT-CONTROLLER, model (M), with gain in time of breakdown AT ,determining a radius of protection of (R) meters, for protection level (L) and insulating between armature superior to the 95%, in weather condition. Tested and certified by the Laboratorio Central Oficial de Electrotecnia, Madrid (Ministry of Industry)

Equipped with triple insulating system protector,stopped electrostatic charge accumulator, upward streamer electronic generator and multiple spark-gap. Wholly made of stainless steel type AIS-316, no need unnatural power supply

TEST ACCREDITATION AND APPLYING STANDARD

1. ESE Air Terminal Qualification Test, proving the gain in time of breakdown, following Annex C of standard UNE 21 186/96 and NF C 17-102/95
 2. Performance test in weather condition, proving that the insulating between armatures, is superior to the 95%, following standard UNE 21 308/89.
- For installation purpose, standard must be considered UNE 21 186/96, NF C 17-102/95, UNE 21 185/95 NTE-IPP pararrayos

		PROTECTION RADIUS (Rp) IN METERS AS CTE SU 8, UNE 21186 and NFC 17102				
GTE SU 8	UNE 21186 NFC 17102	DAT CONTROLLER [®] PLUS				
		h	AT-1515 DC+15	AT-1530 DC+30	AT-1545 DC+45	AT-1560 DC+60
Level 4	Level IV	2	20	28	36	43
		4	41	57	72	85
		6	52	72	90	107
		8	54	73	91	108
Level 3	Level III	10	56	75	92	109
		2	18	25	32	39
		4	36	51	64	78
		6	46	64	81	97
Level 2	Level II	8	47	65	82	98
		10	49	66	83	99
		2	15	22	28	35
		4	30	44	57	69
Level 1	Level I	6	38	55	71	87
		8	39	56	72	87
		10	40	57	72	88
		2	13	19	25	31
Level 1	Level I	4	25	38	51	63
		6	32	48	63	79
		8	33	49	64	79
		10	34	49	64	79

h: air terminal height over the surface to be protected.



AT-01G
Lightning event counter

AT-1515 DAT PLUS-15	AT-1530 DAT PLUS-30	AT-1545 DAT PLUS-45	AT-1560 DAT PLUS-60
Unit / Price ราคา	Unit / Price ราคา	Unit / Price ราคา	Unit / Price ราคา
96,000.00	109,000.00	129,000.00	156,000.00

Accessories for Fitting

Code	Description	Unit / Price ราคา
AT-101	Adapting piece	3,200.00
AT-327	Flat position base	4,400.00
AT-303	Wall mounted anchoring base	2,500.00
AT-201	Mast 1 m Long	1,600.00
AT-202	Mast 2 m Long	2,500.00
AT-203	Mast 3 m Long	3,200.00
AT-01G	Lightning event counter	25,000.00

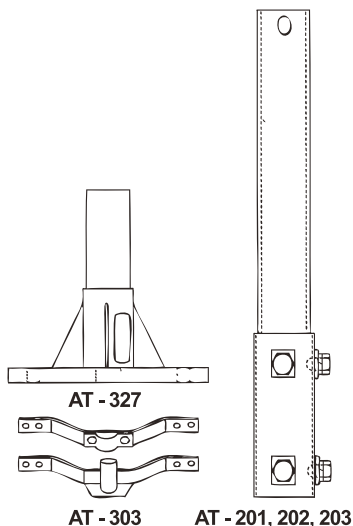

**SURGE AND OVERVOLTAGE PROTECTION
STROM DETECTOR**

**INTERNAL
PROTECTION**



ระบบป้องกันฟ้าผ่าภายใน

TRANSIENT

Transient Overvoltages are caused by a short but very high increase of voltage caused by atmospheric electric discharges (lightning) or by machinery switching manoeuvres.

PROTECTION FOR POWER SUPPLY LINES

อุปกรณ์ป้องกันฟ้าผ่าสำหรับแหล่งจ่ายไฟฟ้ากำลัง



PROTECTION OF DATA AND COMMUNICATION LINES

อุปกรณ์ป้องกันฟ้าผ่าสำหรับอุปกรณ์สื่อสาร



OVERVOLTAGES



PERMANENT

Permanent overvoltages are those having a relatively long duration (several seconds). The usual causes of these overvoltages are a defective connection of the neutral or power consumption drops.



**PREVENTIVE
PROTECTION**



ระบบตรวจวัดสภาพอากาศ

STORM DETECTOR ATSTROM v2

เครื่องมือตรวจวัดสภาพอากาศ is a storm detector by atmospheric electric field measurement, fully electronic, with no mobile parts, robust and most highly reliable. The basic configuration of the ATSTROM v2 storm detector is formed by:



Sensor with FC35 technology



Workstation

Software

Electronic module with 4 contact-free outputs allowing connections to:

- Visual and sonorous alarms
- UPS devices
- Auxiliary power generators
- Data storage
- System access through Internet
- Integration of the equipment into the local networks



CONDUCRETE™

CONDUCTIVE CONDUCRETE FOR GROUNDING



รายละเอียดผลิตภัณฑ์

CONDUCRETE มีลักษณะเป็นผงคล้ายปูนบรรจุในถุงที่มีปริมาณ 25 kg ด้วยคุณสมบัติพิเศษของ CONDUCRETE คือสามารถช่วยแก้ปัญหา Grounding ต่างๆ ที่มีประสิทธิภาพมากขึ้น และเป็นสารที่มีความปลอดภัยต่อสภาพแวดล้อม CONDUCRETE ถูกพัฒนาขึ้นมาเพื่อช่วยแก้ปัญหาการติดตั้งเสาสายส่งไฟฟ้าแรงสูงในบริเวณที่มีพื้นที่เป็นภูเขาหรือพื้นที่ติดดิ่งลำบาก เนื่องจากโดยทั่วไปลักษณะพื้นที่แบบนั้นจะมีค่าความต้านทานเฉพาะของดินสูง CONDUCRETE จึงพิสูจน์ให้เห็นได้ว่ามีประสิทธิภาพ สามารถใช้กับงานได้อย่างกว้างขวาง เช่น Grounding แบบวิธี Grid ในโรงงานไฟฟ้า หรือภายในสถานีไฟฟ้าย่อยระบบการสื่อสารต่างๆ เสาสัญญาณวิทยุ การวางระบบคอมพิวเตอร์ และระบบการป้องกัน การสึกกร่อนขั้วบวกไฟฟ้า (Cathodic Protection) CONDUCRETE ผ่านการทดสอบแล้วว่าไม่เป็นอันตรายต่อสภาพแวดล้อม ด้วยคุณสมบัติที่ไม่เปลี่ยนแปลงง่ายทำให้ระบบ Grounding มีอายุการใช้งานกว่าระบบแบบเดิมและ Copper Electrode ที่ป้องกันด้วย CONDUCRETE จะมีอายุการใช้งานนานกว่าแบบเปลือยถึง 10 เท่า การติดตั้ง CONDUCRETE ทำได้ง่ายๆ โดยเทผง CONDUCRETE ในแนวยาวให้ทับ Conductor ที่วางในร่องที่ขุดขึ้นมา CONDUCRETE จะดูดความชื้นในดินแล้วแข็งกลายเป็นส่วนหนึ่งของ Grounding Electrode เป็นผลให้ค่าความต้านทานของดินลดลงอย่างมากและพื้นที่ผิวรอบๆ Electrode มีค่ามากขึ้น รวมทั้ง Surge impedance ลดลงอีกด้วย การใช้ CONDUCRETE เป็น Electrode นั้นมีประโยชน์ทั้งด้านการทำงานและความปลอดภัยต่อบุคคล CONDUCRETE จึงเป็นผลิตภัณฑ์ที่เหมาะสมอย่างยิ่งกับระบบงานต่างๆ ที่ต้อง Grounding อย่างมีประสิทธิภาพ

CONDUCRETE™ is a conductive cementitious product used in the construction of ground electrodes. For horizontal or vertical installations, CONDUCRETE™ electrodes offer superior performance.

CONDUCRETE™ electrodes are :

- Permanent and maintenance free,
- Cost effective,
- Easy to install,
- Environmentally safe,
- Suitable for all terrain.

For All Grounding Requirements

- Computer Systems
- Industry
- Mining
- Power
- Residence
- Telecommunications
- Utilities



ข้อดีผลิตภัณฑ์

- ไม่ต้องบำรุงรักษาและอายุการใช้งานยาวนาน
- คู่แข่งกับการลงทุน
- ติดตั้งง่าย ใช้ได้กับพื้นดินทุกสภาพ
- ลดความต้านทานของดินได้ถึง 50%
- ลดความเสี่ยงการร่อนของ Grounding Conductor ได้ถึง 90%
- ไม่เป็นอันตรายต่อสภาพแวดล้อม ช่วยการทำงานของอุปกรณ์ Surge impedance ให้ดีขึ้น

ลักษณะการใช้งาน

- Grounding ในโรงงานไฟฟ้า
- Grounding ในสถานีไฟฟ้าย่อย และในโรงงานอุตสาหกรรม
- เสาสัญญาณวิทยุ และสัญญาณไมโครเวฟ
- เสาสายส่งไฟฟ้าแรงสูง และเสาสายส่งไฟฟ้าแรงต่ำ
- โทรคมนาคม : Cellular, Satellite, Fiber Optic
- ระบบงานคอมพิวเตอร์
- แผงควบคุม ไฟฟ้าส่วนกลางในสำนักงาน

Cat No.	Weight Per Bag kg/lbs	Unit / Price ราคา
DM-100	25 kg. / 55 lbs	3,800.00

GROUP B

CABLE ACCESSORIES

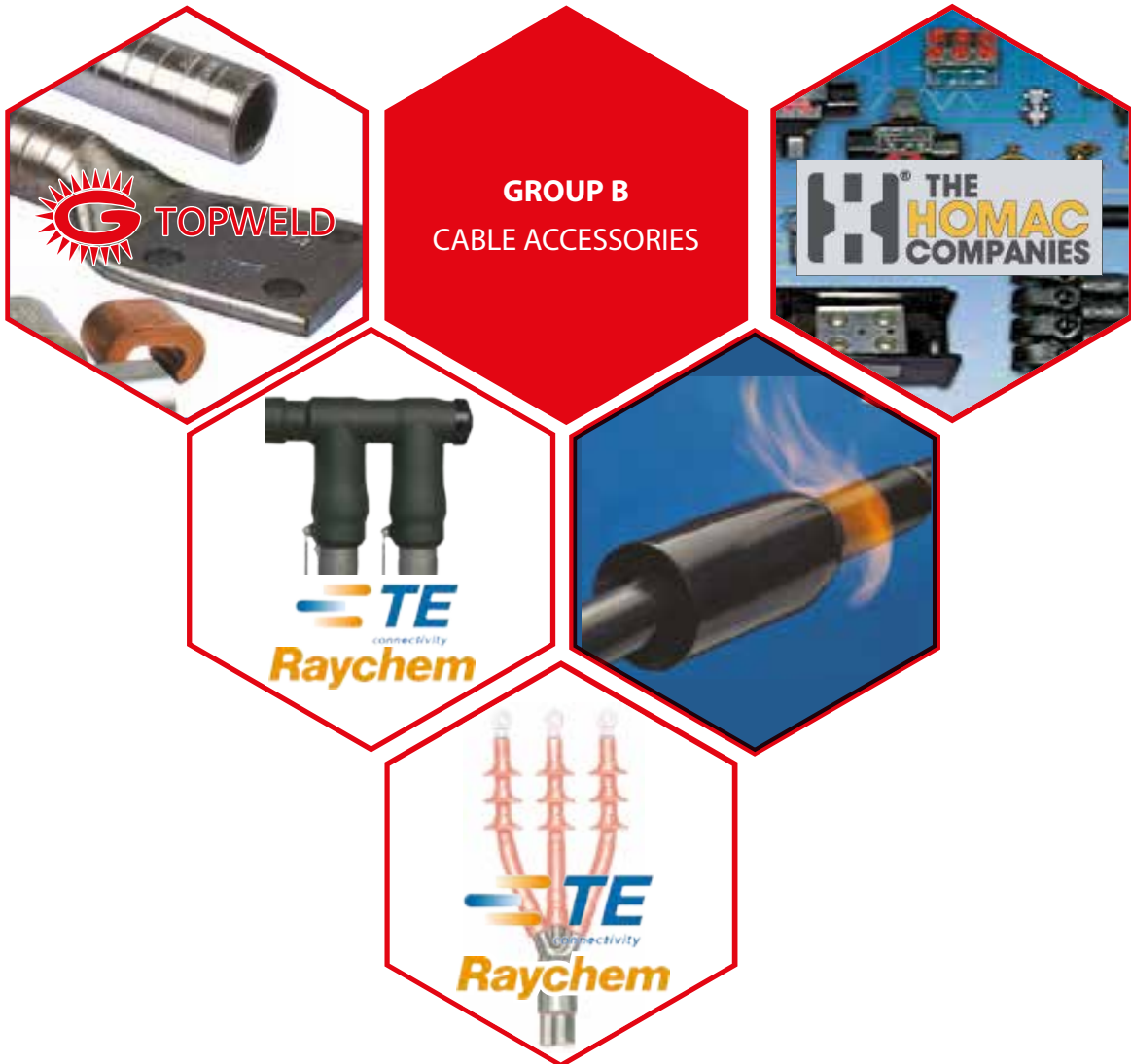



COPPER LUGS TWO-HOLE LONG BARREL

B

Double length barrel permitting two crimps in the larger sizes for additional assurance with heavy duty loads. Seamless, one piece, pure copper construction with tin plating assures maximum conductivity. Generous entrance chamfer provides easy cable insertion. End of cable is fully protected from environment transition. Catalog number and conductor sizes marked on every piece insures positive identification. Can be used with high voltage system up to 35 kv

Part Number	Copper Conductor Size		Stud Size (inch)	Barrel (mm.)		Approximate Dimensions (mm.)							Unit / Price บาท
				I.D.	O.D.	A	W	G	S	C	T	B	
ZLC 8-6 DN	#8 AWG	10mm ²	1/4	4.57	6.85	56.25	11.6	6.35	16	9.4	1.8	20	104.00
ZLC 8-12 D	#8 AWG	10mm ²	1/2	4.57	6.85	101	21.33	16	44.45	16	3	20	240.00
ZLC 6-6 DN	#6 AWG	16mm ²	1/4	5.59	7.87	69	11.6	6.35	16	9.4	2	29	112.00
ZLC 6-12 D	#6 AWG	16mm ²	1/2	5.59	7.87	113.62	21.33	16	44.45	16	3	29	250.00
ZLC 4-6 DN	#4 AWG	25mm ²	1/4	7.11	9.65	70.75	14	6.35	16	9.4	2.4	29	130.00
ZLC 4-12 D	#4 AWG	25mm ²	1/2	7.11	9.65	117.45	21.33	16	44.45	16	3	29	290.00
ZLC 2-6 DN	#2 AWG	35mm ²	5/16	7.87	10.67	78.89	16.7	9.14	19.05	11.17	2.5	29.5	168.00
ZLC 2-12 D	#2 AWG	35mm ²	1/2	7.87	10.67	115.98	21.33	16	44.45	16	3	29.5	310.00
ZLC 1-6 DN	#1 AWG	35mm ²	5/16	9.14	11.94	83.15	18.1	8.12	22.35	11.18	2.5	34.5	192.00
ZLC 1-12 D	#1 AWG	35mm ²	1/2	9.14	11.94	120.95	21.33	16	44.45	16	2.6	34.5	320.00
ZLC 1/0-12 DN	#1/0 AWG	50mm ²	1/2	10.16	13.21	126.45	21.33	16	44.45	16	3	39	340.00
ZLC 2/0-12 DN	#2/0 AWG	70mm ²	1/2	11.43	14.73	127.3	21.33	16	44.45	16	3	39	390.00
ZLC 3/0-12 DN	#3/0 AWG	95mm ²	1/2	12.95	16.25	127.5	24	16	44.45	16	3.2	39	300.00
ZLC 4/0-12 DN	#4/0 AWG	120mm ²	1/2	14.47	18.03	132	27	16	44.45	16	3.4	40	400.00
ZLC 250-12 DN	250 MCM	120mm ²	1/2	16	19.56	131.5	29.5	16	44.45	16	3.5	40	440.00
ZLC 300-12 DN	300 MCM	150mm ²	1/2	16.51	20.57	146.5	31	16	44.45	16	3.7	51	480.00
ZLC 350-12 DN	350 MCM	165mm ²	1/2	17.78	22.35	147	32.5	16	44.45	16	4.4	52	520.00
ZLC 400-12 DN	400 MCM	165mm ²	1/2	19.3	24.13	151.22	35.8	16	44.45	19.05	4.6	52	560.00
ZLC 500-12 DN	500 MCM	240mm ²	1/2	21.34	26.92	155	40	16	44.45	19.05	5.5	59	790.00
ZLC 600-12 DN	600 MCM	300mm ²	1/2	23.37	30.23	171.31	44	16	44.45	19.05	6.4	67.8	1,160.00
ZLC 750-12 DN	750 MCM	400mm ²	1/2	26.16	33.02	181.5	49	16	44.45	19.05	6.5	77	1,360.00
ZLC 800-12 DN	800 MCM	400mm ²	1/2	26.67	34.29	182.5	50	16	44.45	19.05	7.3	79	1,480.00
ZLC 1000-12 DN	1000 MCM	500mm ²	1/2	29.72	38.1	183.5	55	16	44.45	19.05	8.4	79	1,960.00
ZLC 1250-12 DN*	1250 MCM	630mm ²	1/2	33.02	42.87	191.5	62.5	16	44.45	19.05	9.3	81	2,580.00
ZLC 1500-12 DN	1500 MCM	800mm ²	1/2	36.58	46.99	190.5	69	16	44.45	19.05	10.2	81	3,000.00
ZLC 2000-12 DN	2000 MCM	1000mm ²	1/2	41.91	54.35	202.5	80	16	44.45	19.05	12	81	4,160.00

D=Double Hole N=NEMA hole sizes and spacing

* For non-specific die reference, please contact us

TOLERANCE DIMENSION (MM.)							
I.D.	O.D.	A	W	G	C	T	B
± 0.2	± 0.2	± 1.5	± 0.5	± 0.3	± 0.5	± 0.3	± 1.0

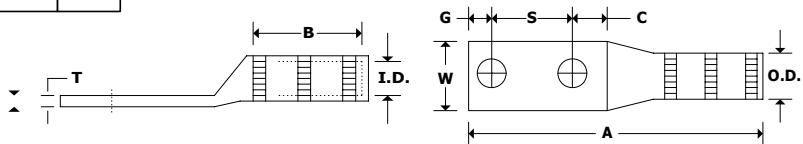

COPPER LUGS ONE-HOLE LONG BARREL

Double length barrel permitting two crimps in the larger sizes for additional assurance with heavy duty loads. Seamless, one piece, pure copper construction with tin plating assures maximum conductivity. Generous entrance chamfer provides easy cable insertion. End of cable is fully protected from environment transition. Catalog number and conductor sizes marked on every piece insures positive identification. Can be used with high voltage system up to 35 kV

Part Number	Copper Conductor Size		Stud Size (inch)	Barrel (mm.)		Approximate Dimensions (mm.)						Unit / Price
				I.D.	O.D.	A	W	G	C	T	B	ราคา
ZIC 8-6 S	#8 AWG	10mm2	1/4	4.10	5.72	43.40	11.60	9.50	9.40	1.80	20.00	68.00
ZIC 8-12 S	#8 AWG	10mm2	1/2	4.10	5.72	53.20	21.33	12.70	16.00	3.00	20.00	168.00
ZIC 6-6 S	#6 AWG	16mm2	1/4	5.80	7.42	57.90	11.60	9.50	9.40	2.00	29.00	70.00
ZIC 6-12 S	#6 AWG	16mm2	1/2	5.80	7.42	67.70	21.33	12.70	16.00	3.00	29.00	176.00
ZIC 4-6 S	#4 AWG	25mm2	1/4	6.40	8.02	59.00	14.00	8.60	9.40	2.40	29.00	78.00
ZIC 4-12 S	#4 AWG	25mm2	1/2	6.40	8.02	69.70	21.33	12.70	16.00	3.00	29.00	192.00
ZIC 2-8 S	#2 AWG	35mm2	5/16	8.50	10.54	59.79	16.70	9.25	11.17	2.50	29.50	102.00
ZIC 2-12 S	#2 AWG	35mm2	1/2	8.50	10.54	68.16	21.33	12.70	16.00	3.00	29.50	204.00
ZIC 1-8 S	#1 AWG	35mm2	5/16	9.50	11.54	69.00	18.10	9.25	11.76	2.50	34.50	120.00
ZIC 1-12 S	#1 AWG	35mm2	1/2	9.50	11.54	75.20	21.00	12.70	16.00	2.60	34.50	220.00
ZIC 1/0-8 S	#1/0 AWG	50mm2	5/16	10.10	12.70	71.57	21.00	9.25	11.17	3.00	39.00	132.00
ZIC 1/0-12 S	#1/0 AWG	50mm2	1/2	10.10	12.70	80.18	21.33	12.70	16.00	3.00	39.00	240.00
ZIC 2/0-10 S	#2/0 AWG	70mm2	3/8	11.40	14.00	75.68	21.33	12.70	12.70	3.00	39.00	138.00
ZIC 2/0-12 S	#2/0 AWG	70mm2	1/2	11.40	14.00	79.03	21.33	12.70	16.00	3.00	39.00	260.00
ZIC 3/0-12 S	#3/0 AWG	95mm2	1/2	12.70	15.30	78.70	24.00	12.70	16.00	3.20	39.00	280.00
ZIC 4/0-12 S	#4/0 AWG	120mm2	1/2	14.20	17.34	83.70	27.00	12.70	16.00	3.40	40.00	300.00
ZIC 250-12 S	250 MCM	120mm2	1/2	16.50	19.64	84.00	29.50	12.70	16.00	3.50	40.00	360.00
ZIC 300-12 S	300 MCM	150mm2	1/2	17.80	20.94	99.50	31.00	13.46	16.00	3.70	51.00	390.00
ZIC 350-12 S	350 MCM	185mm2	1/2	18.80	21.94	97.50	32.50	13.46	16.00	4.40	52.00	420.00
ZIC 400-16 S	400 MCM	185mm2	1/2	19.70	23.36	106.00	35.80	16.76	17.52	4.60	52.00	500.00
ZIC 500-16 S	500 MCM	240mm2	1/2	21.10	24.76	110.25	40.00	16.76	17.52	5.50	59.00	580.00
ZIC 600-16 S	600 MCM	300mm2	1/2	23.40	27.98	136.50	44.00	20.35	20.35	6.40	67.80	880.00
ZIC 750-16 S	750 MCM	400mm2	1/2	27.05	31.93	151.25	49.00	20.35	20.35	6.50	77.00	1,160.00
ZIC 800-16 S	800 MCM	400mm2	1/2	27.40	32.28	154.00	50.00	20.35	20.35	7.30	79.00	1,240.00
ZIC 1000-16 S	1000 MCM	500mm2	1/2	30.70	36.28	160.00	55.00	24.63	24.63	8.40	79.00	1,720.00
ZIC 1250-20 S*	1250 MCM	630mm2	3/4	33.02	42.67	166.55	62.50	26.92	26.92	9.30	81.00	2,000.00
ZIC 1500-20 S	1500 MCM	800mm2	3/4	36.58	46.99	165.85	69.00	26.92	26.92	10.20	81.00	2,600.00
ZIC 2000-20 S	2000 MCM	1000mm2	3/4	41.91	54.36	174.84	80.00	26.92	26.92	12.00	81.00	3,760.00

S=Singel Hole

* For non-specific die reference, please contact us

TOLERANCE DIMENSION (MM.)							
I.D.	O.D.	A	W	G	C	T	B
± 0.2	± 0.2	± 1.5	± 0.5	± 0.3	± 0.5	± 0.3	± 1.0

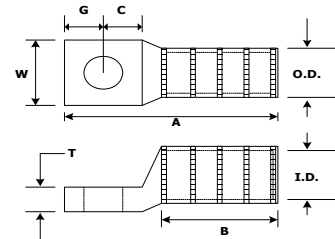



COPPER LUGS TWO-HOLE LONG BARREL °90 PAD

B

Double length barrel permitting two crimps in the larger sizes for additional assurance with heavy duty loads. Seamless, one piece, pure copper construction with tin plating assures maximum conductivity. Generous entrance chamfer provides easy cable insertion. End of cable is fully protected from environment transition Catalog number and conductor sizes marked on every piece insures positive identification. Can be used with high voltage system up to 35 kV

Part Number	Copper Conductor Size		Stud Size (inch)	Barrel (mm.)		Approximate Dimensions (mm.)						Unit / Price
				I.D.	O.D.	W	G	S	C	T	B	ราคา
ZAC 8-6 DN	#8 AWG	10mm ²	1/4	4.10	5.72	11.60	6.35	16.00	9.40	1.80	20.00	124.00
ZAC 8-12 D	#8 AWG	10mm ²	1/2	4.10	5.72	21.33	16.00	44.45	16.00	3.00	20.00	260.00
ZAC 6-6 DN	#6 AWG	16mm ²	1/4	5.80	7.42	11.60	6.35	16.00	9.40	2.00	29.00	132.00
ZAC 6-12 D	#6 AWG	16mm ²	1/2	5.80	7.42	21.33	16.00	44.45	16.00	3.00	29.00	270.00
ZAC 4-6 DN	#4 AWG	25mm ²	1/4	6.40	8.02	14.00	6.35	16.00	9.40	2.40	29.00	150.00
ZAC 4-12 D	#4 AWG	25mm ²	1/2	6.40	8.02	21.33	16.00	44.45	16.00	3.00	29.00	280.00
ZAC 2-8 DN	#2 AWG	35mm ²	5/16	8.50	10.54	16.70	9.14	19.05	11.17	2.50	29.50	188.00
ZAC 2-12 D	#2 AWG	35mm ²	1/2	8.50	10.54	21.33	16.00	44.45	16.00	3.00	29.50	330.00
ZAC 1-8 DN	#1 AWG	35mm ²	5/16	9.50	11.54	18.10	8.12	22.35	11.18	2.50	34.50	210.00
ZAC 1-12 D	#1 AWG	35mm ²	1/2	9.50	11.54	21.33	16.00	44.45	16.00	2.60	34.50	340.00
ZAC 1/0-12 DN	#1/0 AWG	50mm ²	1/2	10.10	12.70	21.33	16.00	44.45	16.00	3.00	39.00	380.00
ZAC 2/0-12 DN	#2/0 AWG	70mm ²	1/2	11.40	14.00	21.33	16.00	44.45	16.00	3.00	39.00	400.00
ZAC 3/0-12 DN	#3/0 AWG	95mm ²	1/2	12.70	15.30	24.00	16.00	44.45	16.00	3.20	39.00	420.00
ZAC 4/0-12 DN	#4/0 AWG	120mm ²	1/2	14.20	17.34	27.00	16.00	44.45	16.00	3.40	40.00	440.00
ZAC 250-12 DN	250 MCM	120mm ²	1/2	16.50	19.64	29.50	16.00	44.45	16.00	3.50	40.00	480.00
ZAC 300-12 DN	300 MCM	150mm ²	1/2	17.80	20.94	31.00	16.00	44.45	16.00	3.70	51.00	520.00
ZAC 350-12 DN	350 MCM	185mm ²	1/2	18.80	21.94	32.50	16.00	44.45	16.00	4.40	52.00	560.00
ZAC 400-16 DN	400 MCM	185mm ²	1/2	19.70	23.36	35.80	16.00	44.45	19.05	4.60	52.00	600.00
ZAC 500-12 DN	500 MCM	240mm ²	1/2	21.10	24.76	40.00	16.00	44.45	19.05	5.50	59.00	870.00
ZAC 600-12 DN	600 MCM	300mm ²	1/2	23.40	27.98	44.00	16.00	44.45	19.05	6.40	67.80	1,240.00
ZAC 750-12 DN	750 MCM	400mm ²	1/2	27.05	31.93	49.00	16.00	44.45	19.05	6.50	77.00	1,440.00
ZAC 800-12 DN	800 MCM	400mm ²	1/2	27.40	32.28	50.00	16.00	44.45	19.05	7.30	79.00	1,560.00
ZAC 1000-12 DN	1000 MCM	500mm ²	1/2	30.70	36.28	55.00	16.00	44.45	19.05	8.40	79.00	2,040.00
ZAC 1500-12 DN	1500 MCM	800mm ²	1/2	36.58	46.99	69.00	16.00	44.45	19.05	10.20	81.00	3,100.00
ZAC 2000-12 DN	2000 MCM	1000mm ²	1/2	41.91	54.36	80.00	16.00	44.45	19.05	12.00	81.00	4,360.00

D=Double Hole N=NEMA hole sizes and spacing

TOLERANCE DIMENSION (MM.)							
I.D.	O.D.	A	W	G	C	T	B
± 0.2	± 0.2	± 1.5	± 0.5	± 0.3	± 0.5	± 0.3	± 1.0

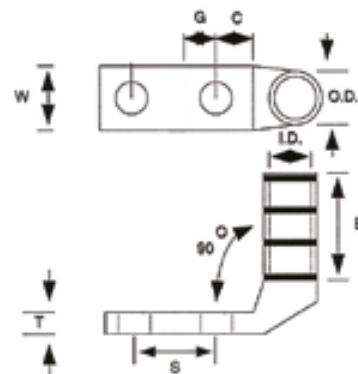

COPPER LUGS ONE-HOLE LONG BARREL °90 PAD

Double length barrel permitting two crimps in the larger sizes for additional assurance with heavy duty loads. Seamless, one piece, pure copper construction with tin plating assures maximum conductivity. Generous entrance chamfer provides easy cable insertion. End of cable is fully protected from environment transition Catalog number and conductor sizes marked on every piece insures positive identification. Can be used with high voltage system up to 35 kV

Part Number	Copper Conductor Size		Stud Size (inch)	Barrel (mm.)		Approximate Dimensions (mm.)					Unit / Price ราคา
				I.D.	O.D.	W	G	C	T	B	
ZAC 8-6 S	#8 AWG	10mm ²	1/4	4.10	5.72	11.60	9.50	9.40	1.80	20.00	84.00
ZAC 8-12 S	#8 AWG	10mm ²	1/2	4.10	5.72	21.33	12.70	16.00	3.00	20.00	188.00
ZAC 6-6 S	#6 AWG	16mm ²	1/4	5.80	7.42	11.60	9.50	9.40	2.00	29.00	110.00
ZAC 6-12 S	#6 AWG	16mm ²	1/2	5.80	7.42	21.33	12.70	16.00	3.00	29.00	196.00
ZAC 4-6 S	#4 AWG	25mm ²	1/4	6.40	8.02	14.00	8.60	9.40	2.40	29.00	98.00
ZAC 4-12 S	#4 AWG	25mm ²	1/2	6.40	8.02	21.33	12.70	16.00	3.00	29.00	212.00
ZAC 2-8 S	#2 AWG	35mm ²	5/16	8.50	10.54	16.70	9.25	11.17	2.50	29.50	122.00
ZAC 1-12 S	#2 AWG	35mm ²	1/2	8.50	10.54	21.33	12.70	16.00	3.00	29.50	224.00
ZAC 1-8 S	#1 AWG	35mm ²	5/16	9.50	11.54	18.10	9.25	11.76	2.50	34.50	140.00
ZAC 1-12 S	#1 AWG	35mm ²	1/2	9.50	11.54	21.00	12.70	16.00	2.60	34.50	240.00
ZAC 1/0-8 S	#1/0 AWG	50mm ²	5/16	10.10	12.70	21.00	9.25	11.17	3.00	39.00	152.00
ZAC 1/0-12 S	#1/0 AWG	50mm ²	1/2	10.10	12.70	21.33	12.70	16.00	3.00	39.00	260.00
ZAC 2/0-10 S	#2/0 AWG	70mm ²	3/8	11.40	14.00	21.33	12.70	12.70	3.00	39.00	158.00
ZAC 2/0-12 S	#2/0 AWG	70mm ²	1/2	11.40	14.00	21.33	12.70	16.00	3.00	39.00	280.00
ZAC 3/0-12 S	#3/0 AWG	95mm ²	1/2	12.70	15.30	24.00	12.70	16.00	3.20	39.00	320.00
ZAC 4/0-12 S	#4/0 AWG	120mm ²	1/2	14.20	17.34	27.00	12.70	16.00	3.40	40.00	340.00
ZAC 250-12 S	250 MCM	120mm ²	1/2	16.50	19.64	29.50	12.70	16.00	3.50	40.00	400.00
ZAC 300-12 S	300 MCM	150mm ²	1/2	17.80	20.94	31.00	13.46	16.00	3.70	51.00	430.00
ZAC 350-12 S	350 MCM	185mm ²	1/2	18.80	21.94	32.50	13.46	16.00	4.40	52.00	460.00
ZAC 400-16 S	400 MCM	185mm ²	5/8	19.70	23.36	35.80	16.76	17.52	4.60	52.00	540.00
ZAC 500-16 S	500 MCM	240mm ²	5/8	21.10	24.76	4.00	16.76	17.52	5.50	59.00	660.00
ZAC 600-16 S	600 MCM	300mm ²	5/8	23.40	27.98	44.00	22.35	22.35	6.40	67.80	940.00
ZAC 750-16 S	750 MCM	400mm ²	5/8	27.05	31.93	49.00	22.35	26.90	6.50	77.00	1,240.00
ZAC 800-16 S	800 MCM	400mm ²	5/8	27.40	32.28	50.00	22.35	28.65	7.30	79.00	1,440.00
ZAC 1000-16 S	1000 MCM	500mm ²	5/8	30.70	36.28	55.00	24.63	31.37	8.40	79.00	2,000.00
ZAC 1500-20 S	1500 MCM	800mm ²	3/4	36.58	46.99	69.00	26.92	26.92	10.20	81.00	2,800.00
ZAC 2000-20 S	2000 MCM	1000mm ²	3/4	41.91	54.36	80.00	26.92	26.92	12.00	81.00	3,960.00

S=Single Hole

TOLERANCE DIMENSION (MM.)							
I.D.	O.D.	A	W	G	C	T	B
± 0.2	± 0.2	± 1.5	± 0.5	± 0.3	± 0.5	± 0.3	± 1.0

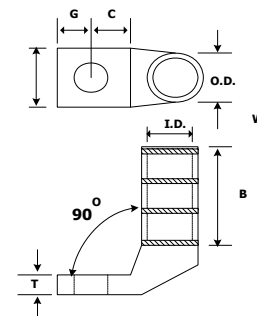



COPPER LUGS LONG BARREL LONG & SHORT PAD BLANK

B

Double length barrel permitting two crimps in the larger sizes for additional assurance with heavy duty loads. Seamless, one piece, pure copper construction with tin plating assures maximum conductivity. Generous entrance chamfer provides easy cable insertion. End of cable is fully protected from environment transition Catalog number and conductor sizes marked on every piece insures positive identification. Can be used with high voltage system up to 35 kV

ZBC PAD BLAN

Reduce your inventory levels and customize your hole and spacing requirements with blank PAD

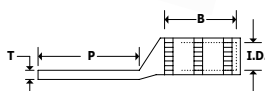
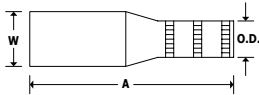

Part Number	Copper Conductor Size		Barrel (mm.)		Approximate Dimensions (mm.)					Unit / Price ราคา
			I.D.	O.D.	A	W	P	T	B	
ZBC 1/0 L	#1/0 AWG	50mm ²	10.10	12.70	126	21.30	76	3	39	340.00
ZBC 2/0 L	#2/0 AWG	70mm ²	11.40	14.00	127	21.30	76	3	39	360.00
ZBC 3/0 L	#3/0 AWG	95mm ²	12.70	15.30	130	24.00	76	3	39	380.00
ZBC 4/0 L	#4/0 AWG	120mm ²	14.20	17.34	132	27.00	76	3	40	400.00
ZBC 250 L	250 MCM	120mm ²	16.50	19.64	132	29.50	76	4	40	440.00
ZBC 300 L	300 MCM	150mm ²	17.80	20.94	147	31.00	76	4	51	480.00
ZBC 350 L	350 MCM	185mm ²	18.80	21.94	147	32.50	76	4	52	520.00
ZBC 400 L	400 MCM	185mm ²	19.70	23.36	151	35.80	80	5	52	560.00
ZBC 500 L	500 MCM	240mm ²	21.10	24.76	155	40.00	80	6	59	790.00
ZBC 600 L	600 MCM	300mm ²	23.40	27.98	171	44.00	80	6	67.8	1,160.00
ZBC 750 L	750 MCM	400mm ²	27.05	31.93	182	49.00	80	7	77	1,360.00
ZBC 800 L	800 MCM	400mm ²	27.40	32.28	183	50.00	80	7	79	1,480.00
ZBC 1000 L	1000 MCM	500mm ²	30.70	36.28	184	55.00	80	8	79	1,960.00
ZBC 1250 L*	1250 MCM	630mm ²	33.02	42.67	192	62.50	80	9	81	2,560.00
ZBC 1500 L	1500 MCM	800mm ²	36.58	46.99	191	69.00	80	10	81	3,000.00
ZBC 2000 L	2000 MCM	1000mm ²	41.91	54.36	203	80.00	80	12	81	4,160.00

Part Number	Copper Conductor Size		Barrel (mm.)		Approximate Dimensions (mm.)					Unit / Price ราคา
			I.D.	O.D.	A	W	P	T	B	
ZBC 1/0 S	#1/0 AWG	50mm ²	10.10	12.70	71.60	21.30	29	3	39	240.00
ZBC 2/0 S	#2/0 AWG	70mm ²	11.40	14.00	79	21.30	29	3	39	260.00
ZBC 3/0 S	#3/0 AWG	95mm ²	12.70	15.30	78.60	24.00	29	3	39	280.00
ZBC 4/0 S	#4/0 AWG	120mm ²	14.20	17.34	83.70	27.00	29	3	40	300.00
ZBC 250 S	250 MCM	120mm ²	16.50	19.64	84	29.50	29	4	40	360.00
ZBC 300 S	300 MCM	150mm ²	17.80	20.94	99.50	31.00	29	4	51	390.00
ZBC 350 S	350 MCM	185mm ²	18.80	21.94	97.50	32.50	29	4	52	420.00
ZBC 400 S	400 MCM	185mm ²	19.70	23.36	106	35.80	34	5	52	500.00
ZBC 500 S	500 MCM	240mm ²	21.10	24.76	110	40.00	34	6	59	580.00
ZBC 600 S	600 MCM	300mm ²	23.40	27.98	137	44.00	45	6	67.8	880.00
ZBC 750 S	750 MCM	400mm ²	27.05	31.93	151	49.00	49	7	77	1,160.00
ZBC 800 S	800 MCM	400mm ²	27.40	32.28	154	50.00	51	7	79	1,240.00
ZBC 1000 S	1000 MCM	500mm ²	30.70	36.28	160	55.00	56	8	79	1,720.00
ZBC 1250 S*	1250 MCM	630mm ²	33.02	42.67	167	62.50	54	9	81	2,000.00
ZBC 1500 S	1500 MCM	800mm ²	36.58	46.99	166	69.00	54	10	81	2,600.00
ZBC 2000 S	2000 MCM	1000mm ²	41.91	54.36	175	80.00	54	12	83	3,760.00

S=Short PAD,
L=Long PAD

TOLERANCE DIMENSION (MM.)							
I.D.	O.D.	A	W	G	C	T	B
±0.2	±0.2	±1.5	±0.5	±0.3	±0.5	±0.3	±1.0

For non-specific die reference, please contact us

COPPER LUGS FOUR-HOLE LONG BARREL



Double length barrel permitting two crimps in the larger sizes for additional assurance with heavy duty loads. Seamless, one piece, pure copper construction with tin plating assures maximum conductivity. Generous entrance chamfer provides easy cable insertion. End of cable is fully protected from environment transition. Catalog number and conductor sizes marked on every piece insures positive identification. Can be used with high voltage system up to 35 kV

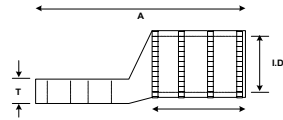
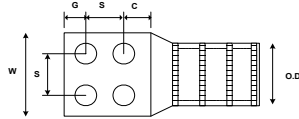

Part Number	Copper Conductor Size	Stud Size (inch)	Barrel (mm.)		Approximate Dimensions (mm.)						Unit / Price ราคา
			I.D.	O.D.	A	W	G	S	C	T	
ZFC 250-12-4N	250MCM	1/2	16.50	19.64	134.5	76.2	16	44.5	19	4	2,500.00
ZFC 300-12-4N	300MCM	1/2	17.80	20.94	149.5	76.2	16	44.5	19	5	2,800.00
ZFC 350-12-4N	350MCM	1/2	18.80	21.94	148.5	76.2	16	44.5	19	5	2,800.00
ZFC 400-12-4N	400MCM	1/2	19.70	23.36	151.5	76.2	16	44.5	19	5	2,900.00
ZFC 500-12-4N	500MCM	1/2	21.10	24.76	155	76.2	16	44.5	19	6	2,900.00
ZFC 600-12-4N	600MCM	1/2	23.40	27.98	171.3	76.2	16	44.5	19	7	3,200.00
ZFC 750-12-4N	750MCM	1/2	27.05	31.93	181.5	76.2	16	44.5	19	7	3,200.00
ZFC 800-12-4N	800MCM	1/2	27.40	32.28	182.5	76.2	16	44.5	19	7	3,200.00
ZFC 1000-12-4N	1000MCM	1/2	30.70	36.28	183.5	76.2	16	44.5	19	9	3,600.00
ZFC 1250-12-4N*	1250MCM	1/2	33.02	42.67	191.5	76.2	16	44.5	19	10	3,600.00
ZFC 1500-12-4N	1500MCM	1/2	36.58	46.99	190.5	76.2	16	44.5	19	10	3,600.00
ZFC 2000-12-4N	2000MCM	1/2	41.91	54.36	204	77.7	16	44.5	19	12	4,000.00

N=NEMA hole sizes and spacing
For non-specific die reference, contact factory

COPPER SPLICES LONG BARREL

ZIP CRIMP SPLICES FOR # 8 STRANDED THRU 2000 MCM

Seamless, one piece, pure copper construction with tin plating assures maximum conductivity. Generous entrance chamfer provides easy cable insertion. Catalog number and conductor sizes marked on every piece to insure positive identification. Positive cable stops insure proper insertion of conductor to full depth.

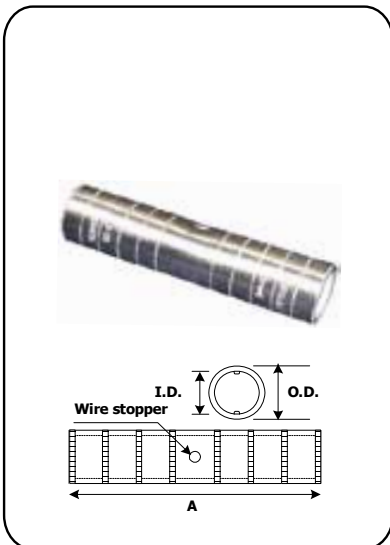

TOLERANCE	I.D.	O.D.	A
DIMENSION (m.m.)	± 0.2	± 0.2	± 1.0

Part Number	Copper Conductor Size	Approximate Dimensions inch			Unit / Price ราคา
		I.D.	O.D.	A	
ZIP 8 L	# 8 AWG	4.10	5.72	57.15	102.00
ZIP 6 L	# 6 AWG	5.80	7.42	60.45	120.00
ZIP 4 L	# 4 AWG	6.40	8.02	60.45	144.00
ZIP 2 L	# 2 AWG	8.50	10.54	66.55	162.00
ZIP 1 L	# 1 AWG	9.50	11.54	72.9	180.00
ZIP 1/0 L	# 1/0 AWG	10.10	12.70	72.9	204.00
ZIP 2/0 L	# 2/0 AWG	11.40	14.00	79.5	216.00
ZIP 3/0 L	# 3/0 AWG	12.70	15.30	79.5	228.00
ZIP 4/0 L	# 4/0 AWG	14.20	17.34	85.6	252.00
ZIP 250 L	250 MCM	16.50	19.64	85.6	264.00
ZIP 300 L	300 MCM	17.80	20.94	104.65	300.00
ZIP 350 L	350 MCM	18.80	21.94	104.65	330.00
ZIP 400 L	400 MCM	19.70	23.36	111	350.00
ZIP 500 L	500 MCM	21.10	24.76	117.35	460.00
ZIP 600 L	600 MCM	23.40	27.98	139.7	650.00
ZIP 750 L	750 MCM	27.05	31.93	149.1	760.00
ZIP 800 L	800 MCM	27.40	32.28	152.4	840.00
ZIP 1000 L	1000 MCM	30.70	36.28	154.45	1,020.00
ZIP 1500 L	1500 MCM	36.58	46.99	165.1	1,440.00
ZIP 2000 L	2000 MCM	41.91	54.36	177.8	2,160.00



CLAMP AND CONNECTORS

B



Copper Parallel Clamp

Copper Parallel Clamp

พี ซี แคลมป์ทองแดง

1 Bolt Conductor Size sq.mm.		Price ราคา
RUN	TAP	
6-50	6-50	80.00
6-70	6-70	85.00
2 Bolt Conductor Size sq.mm.		Price ราคา
RUN	TAP	
70	10	180.00
90	10	250.00
6-35	6-35	150.00
6-70	6-70	180.00
10-95	10-95	250.00
16-95	16-95	250.00

Split Bolt Connector

สปลิตโบลท์คอนเน็คเตอร์



Split Bolt Connector

Conductor Size		Price ราคา
AWG or MCM.	sq.mm.	
10	6	70.00
8	10	70.00
6	16	80.00
4	25	90.00
2	35	120.00
1/0	50	140.00
2/0	70	260.00
3/0	95	480.00
4/0-250	120	520.00
350	185	760.00
500	240	900.00
750	300	1,700.00
1000	400-500	1,980.00

C-TYPE COPPER COMPRESSION CONNECTORS



The range of C-CONNECTORS are manufactured in "C" shaped High purity copper section for connection to main and tap copper conductors.

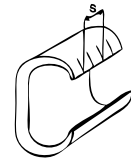
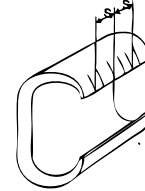
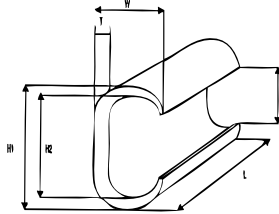

(ZIT-154~ZIT-700)

(ZIT-11~ZIT-122)

Cat. No.	Dimensions mm						Installation		Total sectional area of applicable wire sq.mm.	Unit / Price
	H1	H2	W	L	T	C	#of Crimps	S		
ZIT-11	9.5	6.3	6.2	12	1.6	4.0	2	7	7.5-11	20.00
ZIT-16	11.5	7.8	7.8	13	2.0	5.0	2	8	11.5-16	25.00
ZIT-20	12.8	8.4	9.7	13	2.9	5.1	2	8	14-20	30.00
ZIT-26	14.7	10.2	10.9	16	3.2	6.5	2	8	21-26	35.00
ZIT-44	19.0	13.4	14.4	20	4.0	8.5	2	8	27-44	40.00
ZIT-60	21.0	15.4	15.1	22	4.0	9.7	2	11	45-60	55.00
ZIT-76	24.4	17.3	17.6	22	5.0	10.8	2	11	61-76	70.00
ZIT-98	27.8	20.8	18.8	25	5.0	13.8	2	11	77-98	90.00
ZIT-122	29.8	22.1	21.2	26	5.5	13.5	2	12	99-122	135.00
ZIT-154	34.0	25.7	24.4	28	6.0	17.0	3	8.5	123-154	150.00
ZIT-190	37.0	28.5	25.4	35	6.0	17.4	3	10.5	155-190	195.00
ZIT-240	40.0	30.2	28.5	40	7.0	19.0	3	13	191-240	230.00
ZIT-288	44.5	34.7	31.1	45	7.0	22.3	3	14.5	241-288	250.00
ZIT-365	47.5	37.7	34.0	50	7.0	22.3	3	16	289-365	360.00
ZIT-450	57.0	42.5	41.0	60	10.0	28.0	3	18.5	366-450	650.00
ZIT-560	62.0	46.0	45.0	65	11.0	31.0	3	20	451-560	850.00
ZIT-700	68.0	51.0	49.5	70	12.0	34.0	3	21	561-700	1,000.00



Combination Chart (Applicable range & IZUMI tools to be used)

Conductor main sq.mm.	Conductor tap sq. mm.																
	2	3.5	5.5	8	14	22	30	38	50	60	80	100	125	150	200	250	325
5.5 (Ø2.6)	#11	#11	#11														
8	#11	#16	#11	#16													
14	#16	#20	#20	#26	#44												
22	#26	#26	#44	#44	#44	#44											
30	#44	#44	#44	#44	#44	#60	#60										
38	#44	#44	#44	#60	#60	#76	#76										
50	#60	#60	#60	#60	#76	#76	#98	#98	#122								
60	#76	#76	#76	#76	#76	#98	#98	#98	#122	#122							
80	#98	#98	#98	#98	#98	#122	#122	#122	#122	#154	#154	#190					
100	#122	#122	#122	#122	#122	#122	#154	#154	#154	#190	#190	#190	#240				
125	*154	*154	*154	*154	*154	*154	*190	*190	*190	*190	*240	*240	*288	*288			
150	*154	*154	*190	*190	*190	*190	*190	*190	*190	*240	*240	*240	*288	*288	*365		
200	*240	*240	*240	*240	*240	*240	*240	*240	*240	*288	*288	*288	*365	*365	*365	*450	
250			*288	*288	*288	*288	*288	*288	*288	*365	*365	*365	*365	*450	*450	*450	*560
325			*365	*365	*365	*365	*365	*365	*365	*450	*450		*450	*450	*560	*560	*700
400										*450	*560		*560	*560	*560	*700	*700
500										*560	*560	*700	*700	*700	*700	*700	
600										*700	*700	*700	*700				

Tooling Guide: # EH-2C ## No. 15B * No. 16B ** EP520C

APKT TERMINATION FOR SCREENED SINGLE CORE PLASTIC AND RUBBER INSULATED CABLES

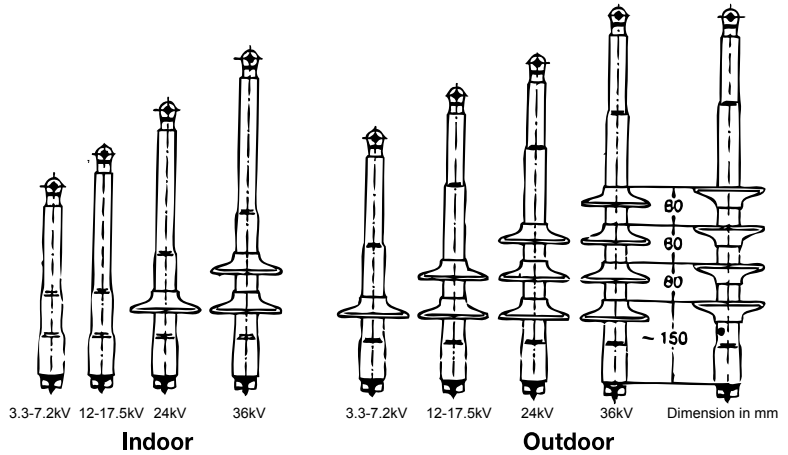

Indoor and Outdoor Termination for Screened Cables for 3.3kV to 36 kV without Armour

Voltage kV.	Size sq.mm.	3 single core per Kit indoor			3 single core per Kit outdoor		
		Type	Cat. No.	Price / ราคา	Type	Cat. No	Price / ราคา
3.3-7.2	16-50	APKT	7A1XI	4,500.00	APKT	7A1XO	9,950.00
	70-120	APKT	7B1XI	4,650.00	APKT	7B1XO	10,800.00
	150-240	APKT	7C1XI	4,950.00	APKT	7C1XO	12,300.00
	300-500	APKT	7D1XI	5,900.00	APKT	7D1XO	14,300.00
	630-1000	APKT	7E1XI	6,400.00	APKT	7E1XO	18,000.00
12-17.5	16-35	APKT	17A1XI	4,800.00	APKT	17A1XO	10,800.00
	50-70	APKT	17B1XI	5,000.00	APKT	17B1XO	11,700.00
	95-240	APKT	17C1XI	5,400.00	APKT	17C1XO	13,300.00
	300-400	APKT	17D1XI	6,200.00	APKT	17D1XO	17,000.00
	500-800	APKT	17E1XI	9,000.00	APKT	17E1XO	22,300.00
	1000	APKT	17F1XI	11,800.00	APKT	17F1XO	27,300.00
24	16-35	APKT	24A1XI	5,000.00	APKT	24A1XO	12,600.00
	50-70	APKT	24B1XI	5,350.00	APKT	24B1XO	13,200.00
	95-185	APKT	24C1XI	5,800.00	APKT	24C1XO	13,800.00
	240-400	APKT	24D1XI	6,600.00	APKT	24D1XO	17,500.00
	500-630	APKT	24E1XI	9,200.00	APKT	24E1XO	21,800.00
	800-1000	APKT	24F1XI	16,600.00	APKT	24F1XO	29,200.00
36	35	APKT	36B1XI	10,500.00	APKT	36B1XO	25,200.00
	50-120	APKT	36C1XI	12,500.00	APKT	36C1XO	27,000.00
	150-185	APKT	36D1XI	13,400.00	APKT	36D1XO	30,200.00
	240-500	APKT	36E1XI	15,200.00	APKT	36E1XO	32,100.00
	630-1000	APKT	36F1XI	22,300.00	APKT	36F1XO	39,900.00

APKT TERMINATION FOR SCREENED SINGLE CORE PLASTIC AND RUBBER INSULATED CABLES

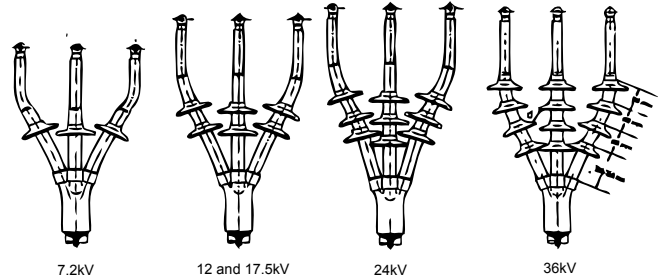
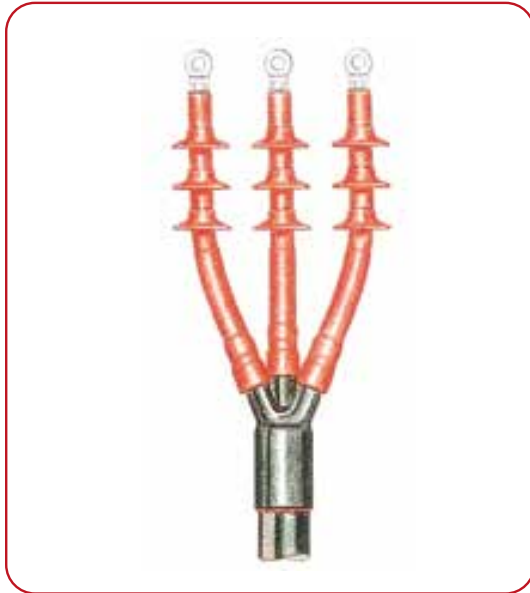

Outdoor

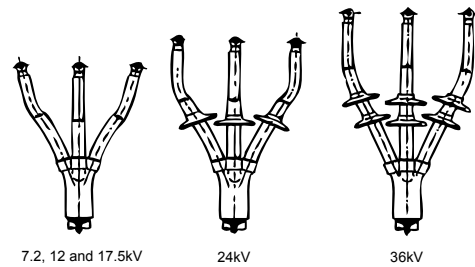

Indoor

Indoor and Outdoor Termination for Screened Cables for 3.3kV to 36 kV without Armour

Voltage kV.	Size sq.mm.	Length of HVTM tubing for cores 3x650 mm. Indoor			Length of HVTM tubing for cores 3.3, 12, 17.5 kV (3x650 mm.) Outdoor		
		Type	Cat. No.	Price / ราคา	Type	Cat. No.	Price / ราคา
3.3 - 7.2	16-50	APKT	7A3XI-H2	5,450.00	APKT	7A3XO-H2	11,400.00
	70-120	APKT	7B3XI-H2	5,850.00	APKT	7B3XO-H2	11,800.00
	150-240	APKT	7C3XI-H2	6,800.00	APKT	7C3XO-H2	13,650.00
	300-500	APKT	7D3XI-H2	8,200.00	APKT	7D3XO-H2	15,700.00
12-17.5	16-35	APKT	17A3XI-H2	6,800.00	APKT	17A3XO-H2	15,200.00
	50-70	APKT	17B3XI-H2	7,400.00	APKT	17B3XO-H2	16,000.00
	95-240	APKT	17C3XI-H2	8,600.00	APKT	17C3XO-H2	18,300.00
	300-400	APKT	17D3XI-H2	9,700.00	APKT	17D3XO-H2	21,000.00
24	25-35	APKT	24A3XI-H2	8,050.00	APKT	24A3XO-H3	23,000.00
	50-70	APKT	24B3XI-H2	10,200.00	APKT	24B3XO-H3	24,000.00
	95-185	APKT	24C3XI-H2	11,800.00	APKT	24C3XO-H3	28,000.00
	240-400	APKT	24D3XI-H2	14,000.00	APKT	24D3XO-H3	33,000.00
36	35	APKT	36B3XI-H2	14,700.00	APKT	36B3XO-H3	30,500.00
	50-120	APKT	36C3XI-H2	17,900.00	APKT	36C3XO-H3	36,000.00
	150-185	APKT	36D3XI-H2	19,800.00	APKT	36D3XO-H3	38,300.00
	240-500	APKT	36E3XI-H2	21,700.00	APKT	36E3XO-H3	42,000.00

EPKJ JOINT FOR SCREENED SINGLE & 3-CORE PLASTIC AND RUBBER INSULATED CABLES JOINT FOR 3.3kV to 36kV WITHOUT ARMOUR

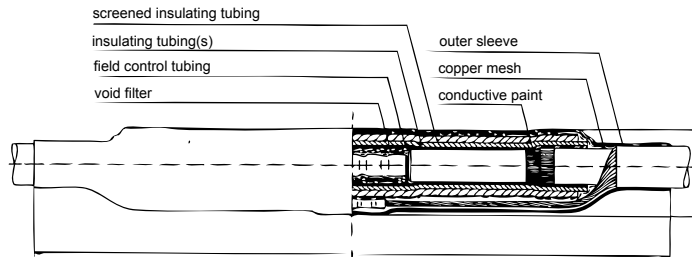
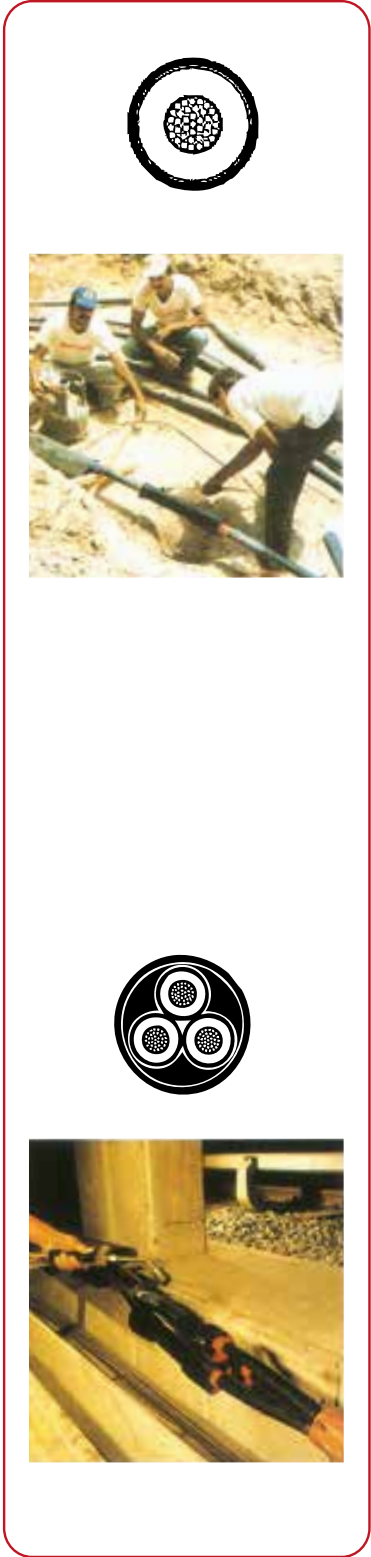

Voltage kV	Size sq.mm.	Single core		Price ราคา
		Type	Cat. No.	
3.3-6.6	25-50	EPKJ	3250	7,750.00
	70-120	EPKJ	3251	8,550.00
	150-185	EPKJ	3252	9,800.00
	240-300	EPKJ	3253	11,300.00
	400-500	EPKJ	3254	14,700.00
12	16-25	EPKJ	3250	7,750.00
	35-70	EPKJ	3251	8,550.00
	95-150	EPKJ	3252	9,800.00
	185-300	EPKJ	3253	11,300.00
	400-500	EPKJ	3254	14,700.00
24	25-50	EPKJ	5256	12,600.00
	70-150	EPKJ	5257	16,100.00
	185-240	EPKJ	5258	18,100.00
	300	EPKJ	5259	19,600.00
36	50-70	EPKJ	6256	17,600.00
	95-150	EPKJ	6257	21,400.00
	185-400	EPKJ	6258	28,400.00

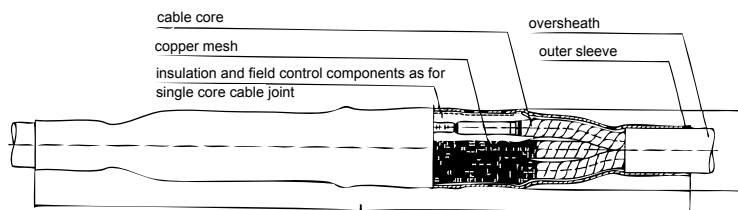

Voltage kV	Size sq.mm.	3-Core		Price ราคา
		Type	Cat. No.	
3.3-6.6	25-50	EPKJ	3240	13,200.00
	70-120	EPKJ	3241	16,300.00
	150-185	EPKJ	3242	19,800.00
	240-300	EPKJ	3243	22,600.00
	16-35	EPKJ	3240	13,200.00
12	50-95	EPKJ	3241	16,300.00
	120-185	EPKJ	3242	19,800.00
	240-300	EPKJ	3243	22,600.00
	70-150	EPKJ	24C3XU-3XU	44,500.00
24	185-240	EPKJ	5267	49,000.00
	300	EPKJ	5268	53,600.00

**Armour Earthing Assembly
For Cable 7.2-36 kV with Wire Armour**

The armour wires of paper or plastic cables can be terminated to earth using mechanical clamping rings.



Cat. No. EAKT-	Description	For Cable O.D. mm.	Price ราคา
1642	Armour Earthing	40-67	8,900.00
1643	Armour Earthing	50-86	11,000.00
1644	Armour Earthing	60-94	14,300.00
1645	Armour Earthing	70-110	16,600.00

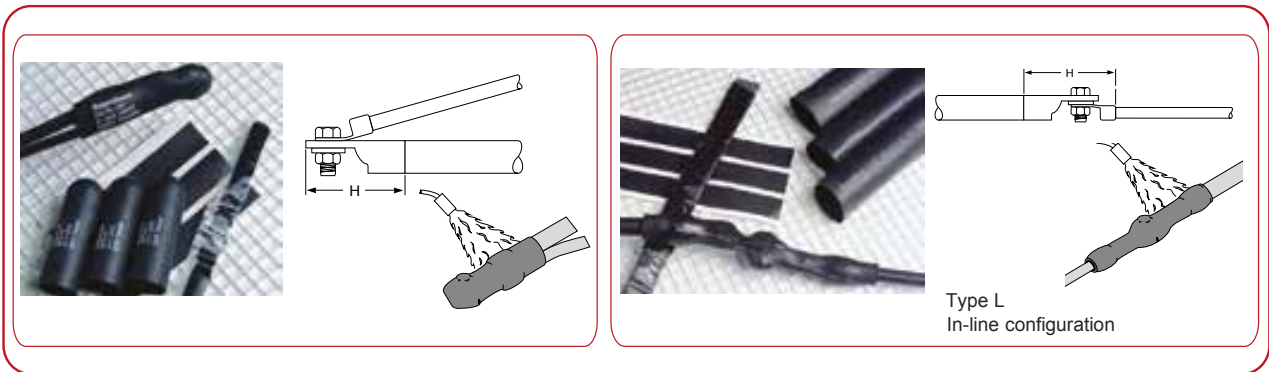

High and low voltage motor connection kit

Cat No.	Type V kV.	Motor feeder size	Maximum allowable bolt length inch	Maximum lug length inch	Nominal cap length inch open barrel	Price
MCK-1V	0.6-2	#14 - #10AWG	5/8	2	2 1/2	950.00
MCK-2V	0.6-2	#12 - #4AWG	3/4	2 1/2	3 1/2	1,570.00
MCK-3V	0.6-2	#2 - #4/0AWG	1	3 1/2	4 1/2	2,300.00
MCK-4V	0.6-2	250-500 MCM	2 1/2	5 1/2	6 1/2	3,970.00
MCK-5-1V-00	5-8	#8 - #2AWG	-	5	7 1/2	8,400.00
MCK-5-2V-00	5-8	#1 AWG - 250 MCM	-	6	8 1/2	10,500.00
MCK-5-3V-00	5-8	300 MCM-750 MCM	-	7	9 1/2	12,550.00

Cat No.	Type L kV.	Motor feeder size	Maximum allowable bolt length inch	Maximum lug length inch	Nominal cap length inch open barrel	Price
MCK-1L	0.6-2	#8-4/0AWG	1 1/4	5	9	2,275.00
MCK-2L	0.6-2	250-1000MCM	1 1/2	8	12	3,400.00
MCK-5-1L-00	5-8	#8AWG-250MCM	-	6	12	10,300.00
MCK-5-2L-00	5-8	300MCM-1000MCM	-	7	14	12,100.00

CABLE BREAKOUTS, “CRSM” WRAP AROUND HVBT HEAT SHRINKABLE BUSBAR TAPE AND ROLL SPRING



“CRSM” Wrap around

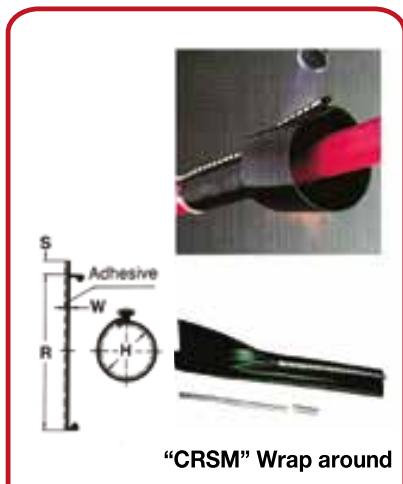

Cat. No. CRSM-	Application Range		Dimensions						Cut Length Price/m. ราคา / เมตร
	Diameter		H		R		W		
	from mm.	to mm.	a min	b max	a min	b max	a min	b max	
34/10	11	21	35	9	110	35	0,30	2,4	5,000.00
53/13	17	32	54	15	170	49	0,30	2,0	5,500.00
84/20	24	50	86	21	270	69	0,30	2,0	6,000.00
107/29	31	65	108	27	340	90	0,30	2,0	7,000.00
143/36	33	86	144	28	455	119	0,30	1,8	8,000.00
198/55	55	120	203	50	640	172	0,30	2,1	10,500.00
250/98	103	150	257	91	810	314	0,40	1,7	11,500.00

HVBT Heat Shrinkable Busbar Tape



Cat. No.	width inch(mm.)	Length Per Roll(M)	Price ราคา
HVBT-12-A	1(25)	10	8,200.00
HVBT-14-A	2(50)		10,700.00
HVBT-15-A	3(75)		14,600.00
HVBT-16-A	4(100)		19,100.00



EPPA 034 is a roll spring

The roll spring is used to attach shielding braid to tape shield of a plastic cable when termination or jointing.

The larger sizes are used for attaching earth braid to lead sheathed cable.

The roll spring is normally used as an integral part of Raychem joints and terminations.

Material: Fatigue resistant stainless steel.

BPTM HEAT-SHRINKABLE INSULATION TUBING
5 to 25kV APPLICATION PER ANSI C37.20C



BPTM Heat-shrinkable Insulation Tubing 5 to 25 kV Applications per ANSI C37.20C
BPTM Selection and Ordering Guide

Cat. No.	Inside diameter (mm)		Wall thickness (mm)		Spool length (M.)	Price / Metre
	H*	h	W	w		
	min	max	nom.	min		
BPTM 15/6-A/U	15	6	1.1	1.90	30.00	1,350.00
BPTM 30/12-A/U	30	12	1.1	2.20	30.00	1,700.00
BPTM 50/20-A/U	50	20	1.1	2.35	30.00	1,900.00
BPTM 75/30-A/U	70	30	1.1	2.35	20.00	2,200.00
BPTM 100/40-A/U	100	40	1.1	2.35	25.00	3,100.00
BPTM 120/50-A/U	120	50	1.3	2.80	25.00	4,300.00
BPTM 175/70-A/U	175	70	1.3	2.80	15.00	8,800.00
BPTM 205/110-A/U	205	110	1.3	2.80	10.00	16,500.00
BPTM 235/130-AU	235	130	1.5	3.10	20.00	โปรดสอบถาม

WCSM heat-shrinkable heavy-wall tubing for insulating and sealing power cables and accessories. In this tubing, the electrical and physical properties of a cable oversheath material are combined with ruggedness and easy installation. The material used is halogen-free and UV-resistant/



WCSM

Dimensions in millimeters
a = as supplied, b = after free recovery

Cat. No. WCSM	Application Range		Dimensions				Cut Length Price/m. ราคา / เมตร
	Diameter		H		W		
	from mm.	to mm.	a min	b max	a min	b max	
12/3	3.5	10.0	12	3	0.8	2.0	1,730.00
16/4	4.5	14.0	16	4	0.9	2.4	1,930.00
24/6	6.5	22.0	24	6	1.0	2.7	2,080.00
34/8	9.0	31.0	33	8	1.3	4.0	2,200.00
48/12	13.0	44.0	48	12	1.5	4.5	2,530.00
56/16	17.5	50.0	56	16	1.5	4.4	2,930.00
70/20	22.0	63.0	70	20	1.0	4.4	3,200.00
90/25	27.5	81.0	90	25	1.3	4.3	3,660.00
110/30	33.0	100.0	110	30	1.3	4.3	3,860.00
130/35	38.0	117.0	130	35	1.0	4.3	4,930.00
160/50	55.0	144.0	160	50	1.0	4.3	6,400.00
180/50	55.0	162.0	180	50	1.0	4.3	7,300.00
200/50	55.0	180.0	200	50	n.a.	4.3	โปรดสอบถาม
250/65	70.0	225.0	250	65	n.a.	4.3	
320/95	105.0	295.0	320	95	n.a.	4.3	
390/110	125.0	350.0	390	110	n.a.	4.3	

RAYCHEM SCREEN SEPARABLE & RAYCHEM SCREENED SEPARABLE COUPLING

RSTI-58 Raychem screened, separable connection system 800A up to 24kV

Screened separable connection system with DIN compression lugs



12kV				24kV			
Cross section (sq.mm.)	Diameter Core Insulation Min-Max (mm)	Reference number Conductor material		Cross section (sq.mm.)	Diameter Core Insulation Min-Max (mm)	Reference number Conductor material	
		Al	Cu			Al	Cu
25	12.7 - 25.0	RSTI-5810	RSTI-5830	25	12.7 - 25.0	RSTI-5810	RSTI-5830
35	12.7 - 25.0	RSTI-5811	RSTI-5831	35	12.7 - 25.0	RSTI-5811	RSTI-5831
50	12.7 - 25.0	RSTI-5812	RSTI-5832	50	12.7 - 25.0	RSTI-5812	RSTI-5832
70	12.7 - 25.0	RSTI-5813	RSTI-5833	70	12.7 - 25.0	RSTI-5813	RSTI-5833
95	12.7 - 25.0	RSTI-5814	RSTI-5834	95	12.7 - 25.0	RSTI-5814	RSTI-5834
120	12.7 - 25.0	RSTI-5815	RSTI-5835	120	12.7 - 25.0	RSTI-5815	RSTI-5835
150	21.3 - 34.6	RSTI-5826	RSTI-5846	150	21.3 - 34.6	RSTI-5826	RSTI-5846
185	21.3 - 34.6	RSTI-5827	RSTI-5847	185	21.3 - 34.6	RSTI-5827	RSTI-5847
240	21.3 - 34.6	RSTI-5828	RSTI-5848	240	21.3 - 34.6	RSTI-5828	RSTI-5848
300	21.3 - 34.6	RSTI-5829	RSTI-5849	300	21.3 - 34.6	RSTI-5829	RSTI-5849

* Kits including deep indent lugs are on request

Screen separable connection system with mechanical lugs and shear bolts

12kV			24kV		
Cross section (sq.mm.)	Diameter Core Insulation Min-Max (mm)	Reference number Conductor material	Cross section (sq.mm.)	Diameter Core Insulation Min-Max (mm)	Reference number Conductor material
		Al or Cu			Al or Cu
35-90	12.7 - 25.0	RSTI-5851	35-70	12.7 - 25.0	RSTI-5851
95-120	12.7 - 25.0	RSTI-5852	95-185	17.0 - 32.6	RSTI-5853
95-240	17.0 - 32.6	RSTI-5853	95-240	21.3 - 34.6	RSTI-5854
150-240	21.3 - 34.6	RSTI-5854	185-300	21.3 - 34.6	RSTI-5855
185-300	21.3 - 34.6	RSTI-5855			

RSTI-CC Raychem screened, separable, coupling connection system, 630A up to 36 (42) kV

Screen separable coupling connection system 36kV with DIN compression lugs



Cross section (sq.mm.)	Diameter Core Insulation Min-Max (mm)	Reference number Conductor material	
		Al	Cu
50	22.4 - 33.6	RSTI-CC-6611	RSTI-CC-6621
70	22.4 - 33.6	RSTI-CC-6612	RSTI-CC-6622
95	22.4 - 33.6	RSTI-CC-6613	RSTI-CC-6623
120	22.4 - 33.6	RSTI-CC-6614	RSTI-CC-6624
150	28.9 - 40.0	RSTI-CC-6615	RSTI-CC-6625
185	28.9 - 40.0	RSTI-CC-6616	RSTI-CC-6626
240	28.9 - 40.0	RSTI-CC-6617	RSTI-CC-6627
300	28.9 - 40.0	RSTI-CC-6618	RSTI-CC-6628

* Kits including deep indent lugs are on request

Screen separable coupling connection system 36kV with mechanical lugs and shear bolts

Cross section (sq.mm.)	Diameter Core Insulation Min-Max (mm)	Reference number Conductor material
		Al or Cu
35-95	22.4 - 33.6	RSTI-CC-6651
95-120	22.4 - 33.6	RSTI-CC-6652
150-240	28.9 - 40.0	RSTI-CC-6653
300	28.9 - 40.0	RSTI-CC-6655

* Kits for 3-core applications on request

PORCELAIN & COMPOSITE OUTDOOR TERMINATION

Porcelain Outdoor Termination for 123kV

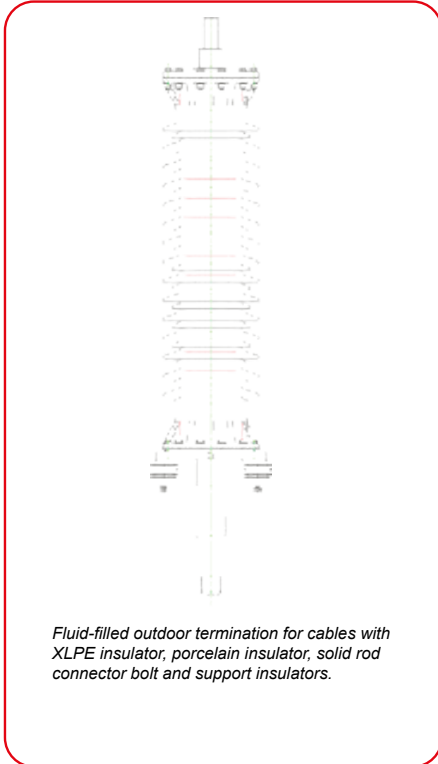

Electrical Data		
Relevant standard	kV	IEC 60840
Rated Voltage	kV	123
Rated frequency	kV	50/60
Lightning impulse voltage 1,2/50us	kV	550
Power frequency voltage with stand dry (30min)	kV	160
Power frequency voltage withstand wet (10s)	kV	230
DC voltage withstand	kV	245
Rated current		as per cable
Rated short-circuit current (conductor) (at pole center distance of 1100mm)	kA	as per cable, <100
Rated short circuit current (sheath) 1s	kA	40
Creepage distance	kA	3906
Total protected creepage (90degree shadow)	mm	2601
Flash-over distance	Mm	1150
Pollution level (IEC 60137, VDE 0674 Teil5)		IV
Withstand Voltage of support insulators (AC/DC)	kV	10/20
Mechanical Data		
Length L	mm	1715
Outer diameter D of insulator	mm	360
Inner diameter of insulator	mm	165
Cantilever force	N	13000
Max permissible radial pull at connection bolt	N	2000
Diameter of connection bolt	mm	50
Length of connection bolt	mm	110
Earth connection		4 x M12
Weight approx.	kg	200

Composite Outdoor Termination for 123kV up to 170kV

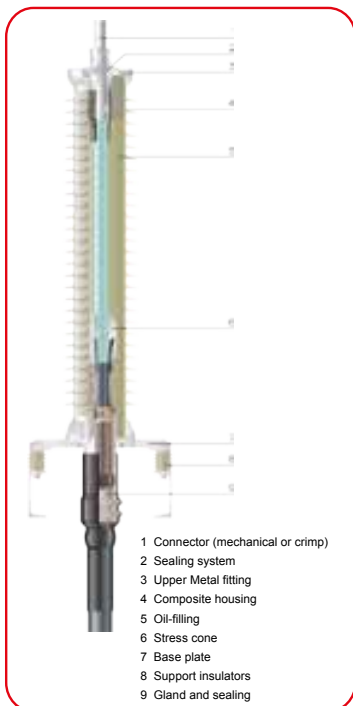

Application

The termination is designed for voltage classes up to 170kV and to operate under severe environmental conditions. Polymeric insulated cables of various designs can be adopted with respect to shielding and metal sheath. Composite housings with different creepage lengths up to 50mm/kV are available covering the most and also extreme pollution level according to IEC 60071-1 1996, IEC 60071-2 1996 and IEEE-1313.1 1996

Features

- Pressure-tight and light weight composite housing
- Pre fabricated and factory tested Si-rubber stress cone
- Torque-controlled conductor bolt
- H/S components used for sealing
- No special tools required to install the termination
- Si-oil filling (filling from the top)
- Isolated base plate for sectionalisation
- Fitting made of corrosion resistant alloy
- Type tested according to IEC 60840 and IEEE 48 standards.



Technical Data		OHVT-145
Highest Voltage U_m	kV	145
Lightning Impulse Voltage	kV	650
Length	mm	1880
Diameter over sheds	mm	294
Cantilever Force	N	5000
Flashover Distance	mm	on demand
Creepage Distance	mm	on demand
Pollution Level (IEC 60137; 1995, VDE 0674, part5)		II
Oil volume approx.	l	35
Weight approx.	kg	120
Max. Conductor size Cu/Al approx.	mm ²	1200
Outer Diameter Cable Insulation	mm	≤90
Outer Diameter Cable Oversheath	mm	≤110

HIGH VOLTAGE SPLICING KIT

Raychem One Piece Joint up to 145kV

Application

The joint is a pre-fabricated one-piece design for voltage classes up to 145kV. Polymeric insulated cables of various designs can be adapted with respect to shielding and metal sheath. The silicone rubber joint body with integrated geometrical stress control provides proven electrical function. The joint components combine electrical performance, stress control and moisture sealing to provide the important functions required for all High Voltage products.

Features

- Premoulded one-piece joint body.
- Torque-controlled connector.
- Choice of outer sealing and protection systems.
- Joint fits on all polymeric cable constructions.
- Proven shield continuity concept.
- Factory tested Silicon-rubber body.
- Special silicone rubber provides perfect compression force for optimised electrical performance.
- Simple assembly.
- No tension set of joint body.
- Moulded thick outer conductive screen.
- Geometrical electrical stress control by moulded conductive deflectors.
- Type tested according to IEC 60840, IEEE 404, GB 11017 standard.
- Manufactured according to ISO 9001 and ISO 14001.

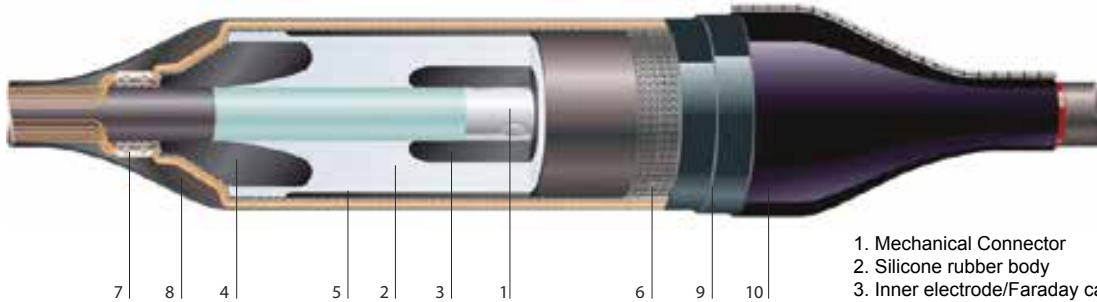

1. Mechanical Connector
2. Silicone rubber body
3. Inner electrode/Faraday cage
4. Deflector
5. Outer Screen
6. Copper mesh
7. Solderless shield connection
8. Sealant/mastic
9. Insulating tubes
10. Outer protection with integrated moisture barrier

Technical data		123 kV
Rated voltage U _{o/U} (U _m)	kV	64/115 (123)
Basic impulse level	kV	550
Max. continuous operating temperature	C	90
Max. conductor emergency temperature	C	150
Conductor shrot circuit temperature	C	250
Short circuit current (sheath)	kA / 1sec	40
Application Range		
Conductor	sq.mm.	up to 1200
Diameter over Insulation	mm	56 - 78
* For special applications and bigger cable sizes please contract us		

Tools

Tool required for cable preparation can also be purchased or rented at Tyco Electronics Energy Division. (See brochure EPP-0756 and EPP-1543)



Cable Stripper



Gas Torch



Straightening slide rails



Tool Box



Heating Blanket

SXSU - MEDIUM VOLTAGE INLINE JOINT
CSJR - COLD SHRINKABLE ISTRAIGHT JOINT

SXSU - Medium Voltage Inline Joints

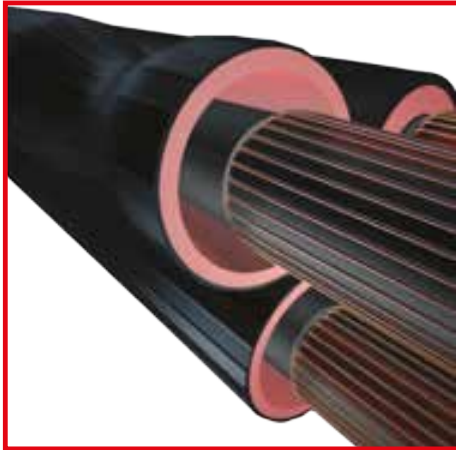

Selection Table		
Rated Voltage	Application range (mm ²)	Cat.No.
24kV	25 - 95	SXSU - 5121
	95 - 240	SXSU - 5131
	240 - 500	SXSU - 5141
	630 - 800	SXSU - 5151
	1000 - 1200	SXSU - 5161
36kV	35 - 95	SXSU - 6121
	95 - 150	SXSU - 6131
	185 - 400	SXSU - 6141
	500 - 800	SXSU - 6151
	800 - 1200	SXSU - 6161
	35 - 150	SXSU - 6122
	150 - 300	SXSU - 6132
	400 - 630	SXSU - 6142
	800 - 1200	SXSU - 6152

CSJR - Raychem cold shrinkable inline joints with Rayvolve EPDM sleeve as outer protection

Raychem joint "CSJR" without connector		
Rated Voltage	Application range (mm ²)	Cat.No.
12kV	95 - 240	CSJR-12B/1XU-1XU
	185 - 300	CSJR-12C/1XU-1XU
	240 - 400	CSJR-12D/1XU-1XU
	500 - 800	CSJR-12E/1XU-1XU
24kV	35 - 185	CSJR-24B/1XU-1XU
	95 - 300	CSJR-24C/1XU-1XU
	185 - 400	CSJR-24D/1XU-1XU
	400 - 630	CSJR-24E/1XU-1XU
36kV	800 - 100	CSJR-24F/1XU-1XU
	70-240	CSJR-36D/1XU-1XU
	240 -630	CSJR-36E/1XU-1XU
	500 - 800	CSJR-36F/1XU-1XU

Raychem joint "CSJR" mechanic connector		
Rated Voltage	Application range (mm ²)	Cat.No.
12kV	95 - 240	CSJR-12B/1XU-1XU-M
	185 - 300	CSJR-12C/1XU-1XU-M
	240 - 400	CSJR-12D/1XU-1XU-M
	500	CSJR-12E/1XU-1XU-M1
	630	CSJR-12E/1XU-1XU-M2
24kV	35 - 150	CSJR-24B/1XU-1XU-M
	95 - 240	CSJR-24C/1XU-1XU-M1
	120 - 300	CSJR-24C/1XU-1XU-M2
	185 - 400	CSJR-24D/1XU-1XU-M
	500	CSJR-24E/1XU-1XU-M
	630	CSJR-24E/1XU-1XU-M2
36kV	95 - 240	CSJR-36D/1XU-1XU-M
	240 - 400	CSJR-36E/1XU-1XU-M1
	500	CSJR-36E/1XU-1XU-M2
	630	CSJR-36E/1XU-1XU-M3



FLOOD SEAL CONNECTOR FOR UNDERGROUND DISTRIBUTION SYSTEMS

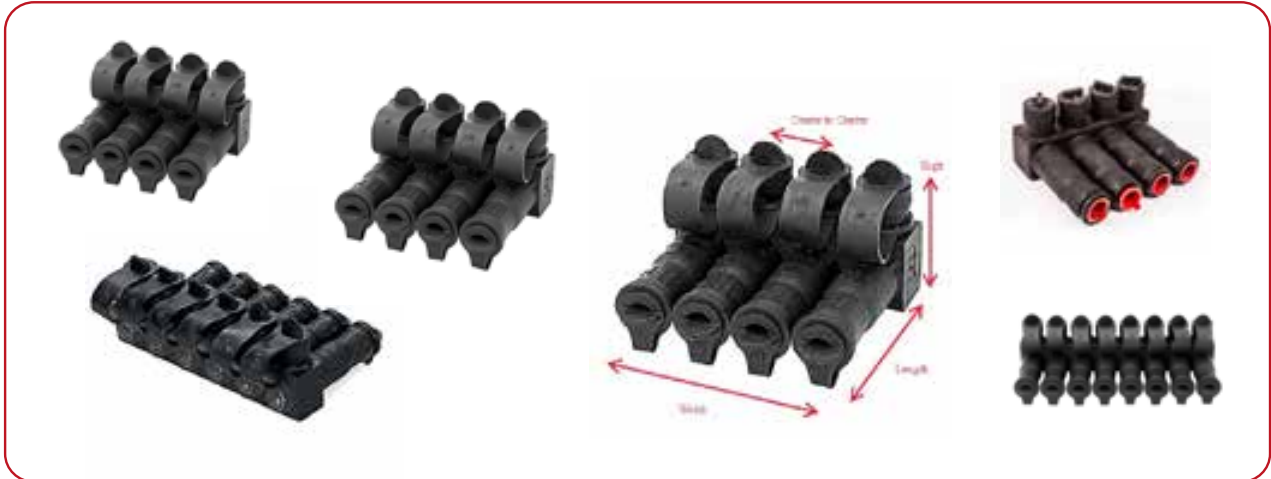

Cat.No.	Conductor Range (AL/CU)	# Outlets	Dimensions (inches)				Price ราคา
			Lenght	Width	Height	Ctr to Ctr	
RAB 2	#12 Sol. - 350 MCM	2	2.44	4.60	2.90	1.187	โปรดสอบถาม
RAB 3		3	3.63				
RAB 4		4	4.82				
RAB 5		5	6.00				
RAB 6		6	7.19				
RAB 8		8	9.56				
RAB 9		9	10.75				
RAB 10		10	11.94				



Cable Cleaning Solvent
 น้ำยาทำความสะอาดสายแรงสูง

Cat.No.	Packing	Price / ราคา
111	1kg / Can	650.00

GROUP C

PROTECTIVE EQUIPMENTS (FUSE, SWITCH & SURGE ARRESTER)



GROUP C
PROTECTIVE
EQUIPMENTS
(FUSE, SWITCH &
SURGE ARRESTER)



FUSE CUTOUT (DROP OUT FUSE CUTOUT) & FUSE LINK



GK Type GFC Fuse Cutout

GK Type GFC Fuse Cutout According to ANSI / IEEE C37.42

Rated kV.	Rated A.	Rated kA.	Rated kV.BIL	Price ราคา
27	100	8	125	3,800.00
27	100	12	125	4,200.00
38	100	10	150	5,500.00



Kearney Type HX Fuse Cutout

Kearney Type HX Fuse Cutout

ครอบเอาท์ ฟิวส์ลิ่งเอาท์

Rated kV	Rated A	Rated kA	Rated kV.BIL	Price ราคา
27	100	12	150	17,000.00
27/35	100	12	150	19,000.00
27	200	10	150	25,000.00
27/35	200	8	150	32,000.00



ABB Type NCX Fuse Cutout

ABB Type NCX Fuse Cutout

Rated kV	Rated A	Rated kA	Rated kV.BIL	Price ราคา
15/27	200	16	125	15,000.00



GK Fuse Cutout (Polluted Area)

GK Fuse Cutout (Polluted Area)

ครอบเอาท์มลภาวะ

Rated kV	Rated A	Rated kA.	Price ราคา
38	100	10	36,000.00



Fuse Link for Fuse Cutout

Fuse Link for Fuse Cutout

ฟิวส์ลิ่ง

Rated Current A	Rated Voltage 15/27 kV Price ราคา	Rated Voltage 35 kV Price ราคา
1,2,3,6	190.00	240.00
8,10,15	200.00	280.00
20,25	220.00	320.00
30,40,50	240.00	420.00
65,80,100	500.00	640.00
140	3,200.00	-
200	3,800.00	-

POLYMER SURGE ARRESTER



**GK Type GST Surge Arrester
Class 2 and Class 3**

GK Polymer Arrester (Polluted Area)

Polymer Arrester (Heavy Duty Riser)

According to IEC 60099-4

Rated kV	Rated kA	Price ราคา
3	5	2,500.00
6	5	2,700.00
9	5	3,000.00
12	5	3,300.00
21	5	3,900.00
24	5	4,400.00
30	5	5,500.00

Rated kV	Rated kA	Price ราคา
3	10	โปรดสอบถาม
6	10	โปรดสอบถาม
9	10	4,000.00
12	10	4,500.00
21	10	4,700.00
24	10	5,500.00
30	10	6,600.00

GK Polymer Arrester (Polluted Area) / ล้อฟ้าโพลีเมอร์ ชนิดมลภาวะ

Rated kV	Rated kA	Price ราคา
30	10	25,000.00

Polymer Arrester ล้อฟ้า โพลีเมอร์ (Heavy Duty Riser)

Rated kV	Rated kA	Price ราคา
3	10	โปรดสอบถาม
6	10	โปรดสอบถาม
9	10	4,500.00
12	10	5,500.00
21	10	6,000.00
24	10	6,500.00
30	10	7,500.00

MEDIUM VOLTAGE FUSE & SWITCH



Single Pole Disconnecting Switch



LT.Switch



HRC Fuse Link Type HFK
TIS 2111 / BS88



L.V. Surge Arrester 5 kA



Voltage Transformer (Oil Type)



Current Transformer (Oil Type)

Single Pole Disconnecting Switch / ดิสคอนเน็คติงสวิทช์

Type	Rated kV	Rated A	Rated kV.BIL	Rated MOM.kA.	Price ราคา
M-72	25.8	600	150	40	9,500.00
M-72	38	600	200	40	18,000.00
H-72	25.8	1200	150	61	25,000.00
H-72	38	1200	200	61	35,000.00
DSP 06025	25.8	600	150	40	7,500.00
DSP 06036	38	600	200	40	12,000.00
DSM 06025	25.8	600	150	40	7,500.00

LT Switch / แอลทีสวิทช์แรงต่ำ

Type	Rated kV	Rated A	Price ราคา
FS-01	0.5	400	960.00

HRC Fuse Link Type HFK / ฟิวส์สวิทช์แรงต่ำ, มอก. 2111

Size	Rating A	Price ราคา
B1	32	70.00
B1	50	80.00
B1	80	90.00
B1	100	100.00
B2	125	130.00
B2	160	140.00
B2	200	150.00
B3	250	230.00
B3	315	250.00
B4	355	330.00
B4	400	350.00

LV.Surge Arrester / ล้อฟ้าแรงต่ำ

Type	Rated V	Rated kA.	Price ราคา
PMS	480	5	800.00

Voltage Transformer (Oil Type) / หม้อแปลงแรงดันไฟฟ้า

Type	Rated		Rated VA	Price ราคา
	kV	V		
VOL-24	24	110	25	38,000.00
VOL-36	36	110	25	50,000.00

Current Transformer (Oil Type) / หม้อแปลงกระแสไฟฟ้า

Type	Rated		Rated Range (A/5A)	Price ราคา
	kV	VA		
COL-24	24	10	20-200	22,000.00
COL-24	24	10	250-600	38,000.00
COL-36	36	10	20-200	30,000.00
COL-36	36	10	250-600	44,000.00

* Dry Type Instrument Transformer is also available upon request.

LIVE PART COVER / WILDLIFE PROTECTORS

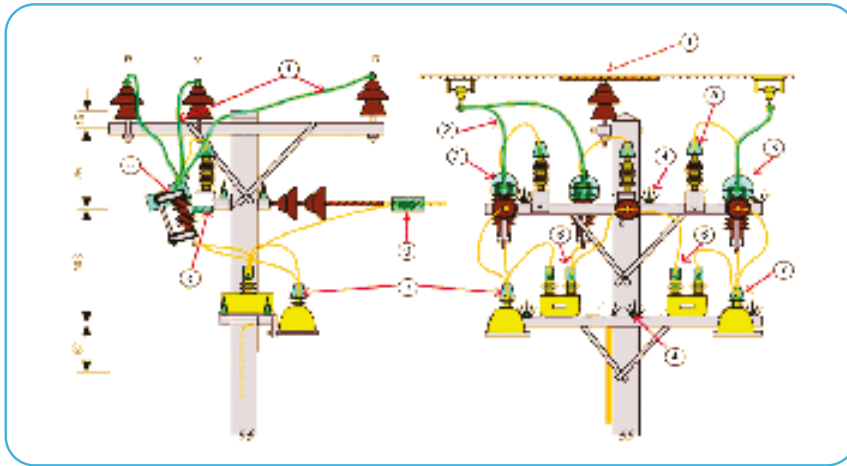

1. Cable Guard
2. Insulating Hose
3. Fuse Cutout Cover
4. Bird Protector Device
5. Insulating Tape
6. Bushing CT Cover
7. Bushing VT Cover
8. Surge Arrester Bird Cap
9. PG Clamp Cover

Typical Live Parts Cover / Wildlife Protector Installation in Distribution Lines

Benefits :

- Protect and prolong useful life of equipments in distribution lines and substation
- Minimizes power outages and maintenance in the distribution systems due to environmental risks
- Durable, economical, easy to install and long life expectancy

Transformer Bushing Cover

The transformer bushing cover used for protection electrical short circuit from animal contacts between live parts of energized equipments. The cover is suitable for bushing terminals of transformer, capacitor, circuit breaker, etc. also used in distribution lines up to 36 kV.

ใช้ในการครอบป้องกัน **Bushing Insulator** ของหม้อแปลงที่ติดตั้งในระบบไฟฟ้า

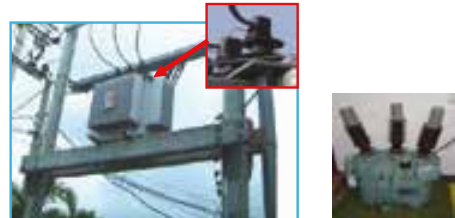

Fuse Cutout Cover

The drop out fuse cover (fuse cutout cover) used for protection the short circuit from animal contacts between live parts of energized equipments. The drop out fuse cover is suitable for distribution lines up to 36 kV and could be covered on the upper and lower parts of fuse cutout that already installed in distribution systems or new equipment.

ใช้ในการครอบส่วน **Live part** ด้านบนของ **Fuse Cutout** เพื่อป้องกันสัตว์

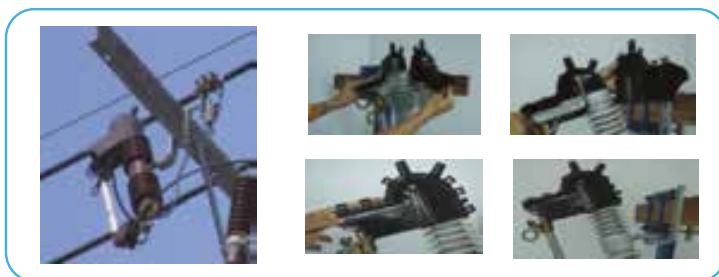

LIVE PART COVER / WILDLIFE PROTECTORS

Lightning Arrester Cover

The lightning arrester (surge arrester) cover used for protection the short circuit from animal contacts between live parts of energized equipments. The lightning arrester cover is suitable for distribution lines upto 36 kV and could be covered on the arrester that already installed in distribution systems or new arrester.

ใช้ในการครอบป้องกัน ด้านบนของอุปกรณ์ล่อฟ้า



Disconnecting Switch Barrier / Animal Guard



The Disconnecting Switch Barrier is designed in round disc to block animals from contacting between phases and/or ground of switches installed in substations or line. The barrier is made of polycarbonate transparent sheet which have high voltage withstand properties. The barrier can left in place for long time without changing or replaced. Other shapes of barrier with different plastic materials are also available upon customer's specific request.

อุปกรณ์ป้องกันสัตว์สัมผัส ดิสคอนเน็คติงสวิทช์

Cable Guard

The Cable Guard is designed to protect conductor from abrasion and contact by tree limbs and animals. It is extruded from track resistant HDPE and can be clipped easily onto the conductors. The Cable Guard shall be supplied in black color with standard length 5ft, other lengths are available upon customer's specific request.

อุปกรณ์ป้องกันต้นไม้เสียดสีกับสายเคเบิล



Secondary Fuse Cover

The Secondary Fuse Cover is designed to insulated the live parts of secondary fuses installed in the lines. It is molded from high strength clear plastic equipped with stainless steel lock to secure it's in place. The cover can be left in place for long time without changing properties.

อุปกรณ์ป้องกัน Secondary Fuse



Bird Protector Device

The Cable Guard is designed to protect conductor from abrasion and contact by tree limbs and animals. It is extruded from track resistant HDPE and can be clipped easily onto the conductors. The Cable Guard shall be supplied in black color with standard length 5ft, other lengths are available upon customer's specific request.

อุปกรณ์ป้องกันนก



LIVE PART COVER / WILDLIFE PROTECTORS

Specification

Picture	Product	Model	Dimension (mm)			Price / ราคา
			W	L	T	
	Bushing Cover (PEA's Spec)	HVB-01	110	115	135	1,000.00
	Bushing Cover (MEA's Spec)	HVB-02	110	115	151	1,000.00
	Bushing Cover (Silicone Type)	HVB-05	132	115	151	1,500.00
	Bushing Cover (Extended lug cover)	TMB-01	170	165	172	1,700.00
	Fuse Cutout Cover	CC-272	112	240	150	1,500.00
	Fuse Cutout Cover (Upper part)	DFC-U-1	108	286	214	1,700.00
	Fuse Cutout Cover (Lower part)	DFC-L-1	85	265	208	1,700.00
	Lightning Arrester Cover	LAC-01	120	165	87	600.00
	PG Clamp Cover	1-Bolt	71	85	1.5	150.00
		2-Bolt	72	88	1.5	200.00
	Secondary Fuse Cover (100A - 150A)	SFC-01	60	150	60	600.00

* Dimension with Tolerance +/- 5%

** Other design is also available upon request

LIVE PART COVER / WILDLIFE PROTECTORS

Specification

Picture	Product	Model	Dimension (mm)			Price / ราคา
			W	L	T	
	Plastic Guard for Flat Brace	PGFB	33	500	65	600.00
	Plastic Cable Guard Standard size	PGC-70	33	1500	65	1,150.00
	Plastic Cable Guard Jumbo size	PGC-185	46	1500	88	1,400.00
	Conductor Cover	CC-38	48	1000	5	1,500.00
	Barrier (Animal Guard for Disconnecting SW.)	BDS-001	3	500	110	3,000.00
อุปกรณ์ป้องกันนก						
	Bird Protector (Spike Unit)	BPD-S	13	178	108	200.00
	Bird Protector (Base Rail) Prefabricated Bird Spike	BPD-BR	19 6.5	1,200 600	11.5 108	800.00
อุปกรณ์ป้องกันงู			Dimension (inch)			
	Snake Guard (Plastic Sheet)	LOC-440	27"	39"	0.006"	50.00
	Snake Guard (Net Type)	LOC-2520	18"	29"		500.00
	(Al. Sheet)	LOC-2859	กว้าง 40"			500.00

* Dimension with Tolerance +/- 5%

** Other design is also available upon request

SF6 GAS LOAD BREAK SWITCH (REMOTE CONTROLLED SWITCH)



SF6 Gas Load Break Switch

Specification	Type	GK-GS2406	GK-GS3606
Rated Voltage	kV	24	36
Continuous Current	A	630	400
BIL	kV	150	170
Frequency	Hz	50 / 60	
Rated Short time Current (1s)	kA	12.5	10
Rated Making Current (Peak)	kV	32.5	25
Rated Power Frequency withstand Voltage			
Dry (1min)	kV	60	70
Wet (10s)	kV	60	
Number of Operation			
Mechanical	Operations	2,000	
Load Switching	Operations	400	
Total Weight	kg	160	185
Price	Manual	300,000.00	350,000.00
	Electrical	350,000.00	400,000.00

sf6 gas or solid Dielectric Insulated recloser

Specification		
Rated Voltage	kV	25.8
Continuous Current	A	630
Frequency	Hz	50 / 60
Rated Symmetrical interrupting current	kA	12.5 / 16
Short time withstand current, 1 sec	kA	12.5 / 16
Making current	kA	32.5 / 41.6
Cable charging interrupting current	A	5
Basic impulse withstand voltage	kV	150
Power frequency withstand voltage, dry	kV	60
Control voltage	AC / DC	AC 220/110V, DC 24V
Mechanical endurance	times	10,000
Price		900,000.00





HIGH VOLTAGE AIR BREAK SWITCH LOAD BREAK SWITCH



Load Break Switch

Air Break Switch

Type: 1G (airbreak) and 1GL (loadbreak)

Orientation: Phase-Over-Phase

Voltage: 15 - 230 KV

Current: 600, 1200, 1600, and 2000 Ampere

Description

A single side-break style switch in a phase-over-phase configuration, with horizontal upright mounting on an aluminum support structure.

Application

Frequently used for line sectionalizing in support of maintenance or fault isolation.

SEECO Catalogue Number and Rating (Air Break)

Voltage Rating			Current Rating		Insulator TR No.	Type 1G		
Nom	Max	BIL	Cont	Mom		Catalog No.	Weight, Lbs	
							without insulator	with insulator
69	72.5	350	600	40	216	1G06906SN	1281	1595
			1200	61		1G06912SN	1341	1655
			1600	70		1G06916SN	1416	1741
			2000	100		1G06920SN	1501	1851
115	121	550	600	40	286	1G11506SN	2462	3360
			1200	61		1G11512SN	2877	3775
			1600	70		1G11516SN	3389	4287
			2000	100		1G11520SN	3791	4689

SEECO Catalogue Number and Rating (Load Break)

Voltage Rating			Current Rating		Insulator TR No.	Type 1GL		
Nom	Max	BIL	Cont	Mom		Catalog No.	Weight, Lbs	
							without insulator	with insulator
69	72.5	350	600	40	216	1GL06906SN	1563	2237
			1200	61		1GL06912SN	1623	2297
			1600	70		1GL06916SN	1698	2383
			2000	100		1GL06929SN	1783	2493
115	121	550	600	40	286	1GL11506SN	2787	3429
			1200	61		1GL11512SN	3202	3844
			1600	70		1GL11516SN	3714	4356
			2000	100		1GL11520SN	4116	4758

POWER FUSE

Power Fuse

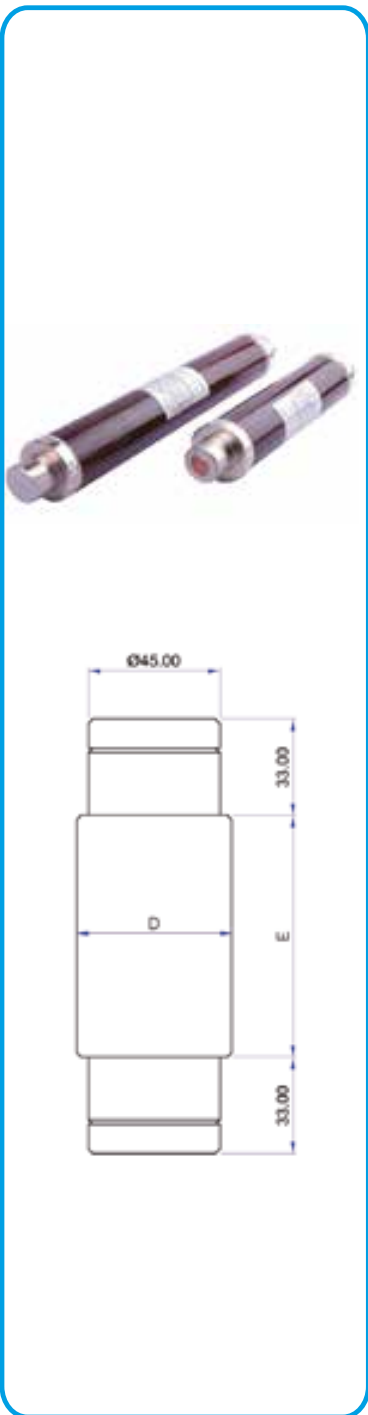

Cat. No.	kV	A	kA	D mm	E mm	Weight kg.	Price ราคา					
000412	12	4	47	55	292	1.6	4,800.00					
000612		6					4,800.00					
001012		10					4,800.00					
001612		16					4,800.00					
002012		20					4,800.00					
002512		25					5,220.00					
003212		32					5,280.00					
004012		40					5,400.00					
005012		50	33	77	292	3	5,520.00					
006312		63					7,200.00					
008012		80					8,100.00					
010012		100					8,100.00					
012512		125					8,400.00					
016012		160					18	10,320.00				
020012		200					12	10,560.00				
000424		24					4	27	55	442	2.3	5,580.00
000624	6		5,580.00									
001024	10		5,580.00									
001624	16		5,580.00									
002024	20		5,580.00									
002524	25		5,760.00									
003224	32		5,940.00									
004024	40		5,940.00									
005024	50		22	77	442	4.5	8,580.00					
006324	63						8,580.00					
008024	80						9,360.00					
010024	100						18	10,320.00				
016024	160						12	14,500.00				
020024	200							20,000.00				
000436	36						4	16	55	537	2.8	6,850.00
000636							6					6,850.00
001036		10	7,600.00									
001636		16	7,600.00									
002036		20	7,600.00									
002536		25	7,800.00									
003236		32	9,200.00									
004036		40	9,200.00									
005036		50	12	77	537	5.1	10,000.00					
006336		63					10,500.00					

CAPACITOR



Low Voltage Power Capacitor

L.V. POWER CAPACITOR TYPE INDOOR and OUTDOOR Type.

Capacitor 230 volts, or 400 volts,50 Hz.,Single or Three phase.

คาปาซิเตอร์

L.V. POWER CAPACITOR 400V, 50Hz, THREE PHASE

Rated kVAR	Rated Current A	Phase	Indoor Price / ราคา	Outdoor Price / ราคา
5	7.2	3	โปรดสอบถาม	4,600.00
10	14.5	3		5,500.00
15	21.6	3		6,400.00
20	28.9	3		7,500.00
25	36.0	3		8,600.00
30	43.3	3		9,600.00
45	65.0	3		12,800.00
50	72.2	3		13,900.00
60	86.6	3		19,000.00
75	108.3	3		18,200.00

L.V. POWER CAPACITOR 230V, 50Hz, SINGLE PHASE

Rated kVAR	Rated Current A	Phase	Indoor Price / ราคา	Outdoor Price / ราคา
5	21.8	1	โปรดสอบถาม	4,900.00
7.5	32.6	1		5,700.00
10	43.5	1		6,400.00
12.5	54.4	1		โปรดสอบถาม
15	65.2	1		โปรดสอบถาม
20	86.9	1		โปรดสอบถาม

GROUP D

INSULATOR, CABLE & HARDWARE ACCESSORIES



GROUP D
INSULATOR, CABLE
HARDWARE ACCESSORIES,
TELEPHONE ACCESSORIES



HIGH & LOW VOLTAGE INSULATORS



Strain Insulator

Strain Insulator

ลูกถ้วยยึดโยง

ANSI Class	Length (inch)	Strength (Lbs)	Price ราคา
54-1	3½	10000	80.00
54-2	4½	12000	100.00
54-3	5½	20000	156.00
54-4	6½	20000	175.00



Pillow Insulator

Pillow Insulator

ลูกถ้วยหมอน

Size	Length (mm.)	Price ราคา
UCS-001	95	260.00
UCS-003	150	920.00
UCS-004	280	1,300.00



Station Post Insulator

Station Post Insulator

ลูกถ้วยที่อาร์

TR. No.	Rated (kV)	Price ราคา
202	7.2	3,500.00
205	11	4,200.00
208	22	4,900.00
210	33	6,500.00
216	69	26,000.00
286	115	36,400.00



Wire Holder

Wire Holder

ลูกถ้วยทางหนู

Size	Price ราคา
Small	20.00
Medium	26.00



Spool Insulator

Spool Insulator

ลูกถ้วยแฉ็ค

ANSI Class	Price ราคา
53-2	40.00

HIGH VOLTAGE INSULATORS



Suspension Insulator



Line Post Insulator



Pin Post Insulator



Fog Insulator Pin Type



Polymer Composite Insulator

Suspension Insulator / ลูกถ้วยแขวน

ANSI Class	Type	Disc Dia inch	Price ราคา
52-1	Clevis & Eye	6	520.00
52-2	Clevis & Eye	7 ¹ / ₂	780.00
52-4	Clevis & Eye	10	980.00
52-3	Ball & Socket	10	1,500.00
52-8	Ball & Socket	10	2,600.00

Line Post Insulator / ลูกถ้วยไลน์โพสต์

ANSI Class	Rated kV	Price ราคา
57-2L	24	1,200.00
57-3L	33	2,350.00
57-4L	46	3,700.00

Pin Post Insulator / ลูกถ้วยพินโพสต์

ANSI Class	Rated kV	Price ราคา
56/57-2L	24	2,100.00
56/57-4L	33	7,200.00

Fog Insulator Pin Type / ลูกถ้วยก้านตรงแบบพ็อกโทปี

ANSI Class	Rated kV	Price ราคา
-	33	3,250.00

Polymer Composite Insulator / ลูกถ้วยแขวนโพลีเมอร์

Type	Rated kV	Price ราคา
Deadend / Suspension	24	2,350.00
Deadend / Suspension	33	3,450.00
Deadend / suspension	115	11,700.00



Cast Resin Insulation

Cast Resin Insulation

ลูกถ้วยแบบ Cast Resin

Cat. No.	Type	Rated		Leakage Distance mm.	Weight kg.	Price ราคา
		kV	kV.BIL			
03350	IGn3	3.6	60	145	0.40	1,240.00
06350	IGn6	7.2	60	195	0.55	1,500.00
10350	IGn10	12	75	235	0.62	1,700.00
20350	IGn20	24	125	390	1.25	2,300.00
30350	IGn30	36	170	550	1.85	3,750.00

HIGH VOLTAGE CABLES



Aluminum Stranded Conductor Partially Insulated Cable

Type PIC สายพหุเสี้ยว

Cable Size (sq.mm.)	Rated 25kV	Rated 35kV
	Price / ราคา	Price / ราคา
25	โปรดสอบถาม	โปรดสอบถาม
35	121	160.00
50	163	206.00
70	180	247.00
95	267	316.00
120	306	364.00
150	312	416.00
185	410	510.00
240	โปรดสอบถาม	โปรดสอบถาม

Aluminum Stranded Conductor Spaced Aerial Cable

Cross-Linked Polyethylene Insulated and Sheathed

Type SAC สายแฉวีเสี้ยว

Cable Size (sq.mm.)	Rated 25kV	Rated 35kV
	Price / ราคา	Price / ราคา
25	โปรดสอบถาม	โปรดสอบถาม
35	305	345.00
50	355	410.00
70	433	490.00
95	527	585.00
120	630	741.00
150	715	832.00
185	836	943.00
240	1,040	1,135.00

Copper Stranded Conductor Cross-Linked Polyethylene Insulated High Voltage Cable

Cross-Linked Polyethylene Insulated and Sheathed

Type XLPE สายใต้ดิน

Cable Size (sq.mm.)	Rated 25kV	Rated 35kV
	Price / ราคา	Price / ราคา
25	โปรดสอบถาม	โปรดสอบถาม
35	1,140.00	1,565.00
50	1,340.00	1,646.00
70	1,612.00	1,940.00
95	1,970.00	2,312.00
120	2,330.00	2,668.00
150	2,673.00	3,052.00
185	3,144.00	3,541.00
240	3,940.00	4,306.00
300	4,792.00	5,078.00
400	5,946.00	6,266.00

LV, MV, HV CONDUCTORS



Aluminum Conductors Insulated and Bare



Ground Wire Cable



Jumper Wire Cable



Drop Wire Cable



Bare Copper Conductors



Steel Strand Wire

Aluminum Conductors Insulated and Bare

สายอลูมิเนียมหุ้ม และสายอลูมิเนียมเปลือย

Cable Size (sq.mm.)	Type THW-A	Type AAC	Type ACSR
	Price (Metre) / ราคา (เมตร)	Price (Metre) / ราคา (เมตร)	Price (Metre) / ราคา (เมตร)
6	-	-	โปรดสอบถาม
10	18.00	-	
16	24.00	-	
25	32.50	10.00	
35	43.00	16.00	
50	57.50	23.00	
70	86.00	34.00	
95	112.00	42.50	
120	146.00	52.20	
150	175.50	70.00	
185	260.00	85.50	
240	350.00	110.00	
300	430.00	141.00	
400	โปรดสอบถาม	178.00	
500	โปรดสอบถาม	235.00	

Ground Wire Cable

สายกราวด์

Size (AWG)	Price / 150 Metre ราคา / 150 เมตร
6	6,000.00
10	2,400.00
14	1,200.00

Jumper Wire Cable

สายจัมเปอร์

Size (sq.mm.)	Price / 200 Metre ราคา / 200 เมตร
2Cx0.5	773.00
2Cx0.65	1,055.00

Drop Wire Cable

สายดรอปไวร์

Size (sq.mm.)	Price / 200 Metre ราคา / 200 เมตร
2Cx0.9	2,400.00
2Cx0.65	โปรดสอบถาม

Bare Copper Conductors

สายทองแดงเปลือย

Size (sq.mm.)	Price ราคา / เมตร
10	42.50
16	66.00
25	102.50
35	145.00
50	195.00
70	278.00
95	385.00
120	486.00
150	595.00
185	747.50
240	980.00
300	1,228.00
400	1,595.00
500	2,000.00

Steel Strand Wire

ลวดเหล็กตีเกลียว

Grade Utility		Price / Metre ราคา / เมตร
Size (sq.mm.)	Strand	
4	Solid	โปรดสอบถาม
25	7	22.00
35	7	29.00
50	7	39.00
95	19	78.00

ลวดเหล็กตีเกลียวรุ่นเอ็กซ์ตร้า

Grade EHS		Price / Metre ราคา / เมตร
Size (inch)	Strand	
1/4	7	23.00
5/16	7	37.00
3/8	7	44.00
7/16	7	84.00
1/2	7	100.00

PREFORMED PRODUCT

Preformed Dead End

“Designed for direct application over jacketed conductor or bare conductors

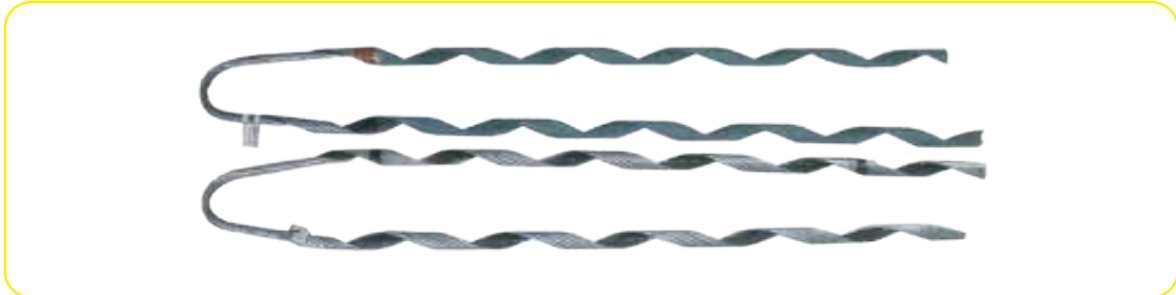

For Aluminum Conductors Insulated

สำหรับสายอลูมิเนียมหุ้ม

Cat. No.	สาย THW-A Size (sq.mm.)	MEA		PEA				Price ราคา
		PE 25 KV (sq.mm.)	XLPE 25 KV (sq.mm.)	PIC 25 KV (sq.mm.)	PIC 35 KV (sq.mm.)	SAC 25 KV (sq.mm.)	SAC 35 KV (sq.mm.)	
PM-0100-ND	16							69.00
PM-0105-ND	25	35						92.00
PM-0107-ND	35							99.00
PM-0110-ND	50	70		35				158.00
PM-0112-ND	70			50	35			172.00
PM-0114-ND	95	120			50			200.00
PM-0115-ND	120							234.00
PM-0116-ND	-			95				300.00
PM-0117-ND	150	185		120	95			370.00
PM-0118-ND	-		35					420.00
PM-0119-ND	185				120	50		480.00
PM-0120-ND	-			185				520.00
PM-0121-ND	-		70		185	70-95	50	570.00
PM-0122-ND	240					120	95	610.00
PM-0124-ND	300		185			185	120	650.00
PM-0125-ND	400						185	820.00
PM-0126-ND	500							855.00

For Bare Conductors

สำหรับสายเปลือย

Cat. No.	Size (sq.mm.)	Price ราคา
PM-4541-DG	25	102.00
PM-4542-DG	35	134.00
PM-4543-DG	1AWG	168.00
PM-4544-DG	50	208.00
PM-4545-DG	70	218.00
PM-4546-DG	95	282.00
PM-4547-DG	120	370.00
PM-4548-DG	150	500.00
PM-4549-DG	185	645.00
PM-4550-DG	240	1,270.00
PM-4552-DG	300	1,450.00
PM-4555-DG	400	1,950.00
PM-4557-DG	500	2,750.00

PREFORMED PRODUCT

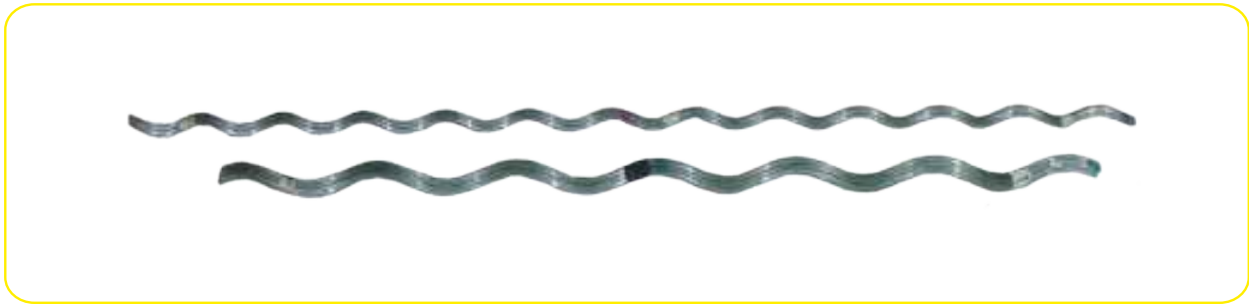

Preformed Line Guard

พรีฟอร์มไลน์การ์ด

Cat. No.	Size (sq.mm.)	Price ราคา
PM-0127-MG	25	80.00
PM-0130-MG	35	98.00
PM-0133-MG	50	116.00
PM-0136-MG	70	150.00
PM-0139-MG	95	190.00
PM-0141-MG	120	217.00
PM-0143-MG	150	300.00
PM-0146-MG	185	350.00
PM-0149-MG	240	460.00

Preformed Armour Rods

พรีฟอร์มอาร์มเมอร์รอด

Cat. No.	Size (sq.mm.)	Price ราคา
PM-0113-AR	35	217.00
PM-0116-AR	50	283.00
PM-0119-AR	70	411.00
PM-0122-AR	95	520.00
PM-0124-AR	120	650.00
PM-0129-AR	185	982.00
PM-0132-AR	240	1,475.00
PM-0137-AR	400	2,540.00
PM-0145-AR	625	4,425.00

Preformed Guy Grips Dead End

พรีฟอร์มกายกริปเดดเอ็น

Cat. No.	Size inch (inch)	Price ราคา
PM-2100-GDE	5/32"	55.00
PM-2102-GDE	3/16"	60.00
PM-2104-GDE	1/4"	92.00
PM-2106-GDE	5/16"	120.00
PM-2107-GDE	3/8"	162.00
PM-2108-GDE	7/16"	396.00
PM-2115-GDE	1/2"	482.00

Preformed Guy Grip for Insulator

พรีฟอร์มกายกริปฟอว์อินซูเลเตอร์

Cat. No.	Size inch (inch)	Price ราคา
PM-2104-GFI	1/4 (4M)	100.00
PM-2106-GFI	5/16 (6M)	123.00
PM-2107-GFI	3/8 (10M)	166.00

Preformed False Dead End

พรีฟอร์มกายกริปฟอลส์เดดเอ็น

Cat. No.	Size inch (inch)	Price ราคา
PM-2204-GDE	1/4 (4M)	102.00
PM-2206-GDE	5/16 (6M)	130.00
PM-2207-GDE	3/8 (10M)	170.00

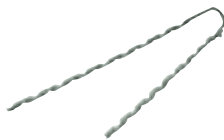

Preformed Guy Grips



Preformed Guy Grip for Insulator



Preformed False Dead End

PREFORMED PRODUCT



Preformed Stranded Splice

Preformed Stranded Splice

พรีฟอร์มสแตนดิสไปรซี

Cat. No.	Size inch (inch)	Price ราคา
PM-2104-GLS	1/4 (4M)	98.00
PM-2106-GLS	5/16 (6M)	122.00
PM-2107-GLS	3/8 (10M)	168.00



Preformed Spiral Vibration Damper

Preformed Spiral Vibration Damper

พรีฟอร์มสไปรัลไวบเรชันดัมเปอร์

Cat. No.	Size (sq. mm.)	Price ราคา
SVD-0104	50-70	700.00
SVD-0105	95-120	790.00
SVD-0106	150-185	1,850.00



Preformed Helical Rod

Preformed Helical Rod

พรีฟอร์มแฮกสาย

Cat. No.	Size (sq.mm.)	Diameter Range		Price ราคา
		Min (mm.)	Max (mm.)	
PM-7426-SU-MS	400	25.27	26.36	945.00

ALUMINUM CONNECTORS



Full Tension Splice for Aluminium Conductor

หลอดต่อสายอลูมิเนียมชนิดรับแรงดึง

Size (sq.mm.)	Length (mm.)	Price ราคา
25	140	32.00
35	140	42.00
50	155	50.00
70	165	64.00
95	165	80.00
120	250	114.00
150	300	138.00
185	330	175.00
240	350	340.00
300	380	660.00
400	380	720.00
625	450	1,600.00

Partial Tension Splice for Aluminium Conductor

หลอดต่อสายอลูมิเนียมชนิดไม่รับแรงดึง

Size (sq.mm.)	Length (mm.)	Price ราคา
25	85	24.00
35	85	32.00
50	85	44.00
70	105	50.00
95	105	72.00
120	105	82.00
150	125	90.00
185	125	102.00
240	145	180.00
300	280	400.00
400	280	600.00
625	350	1,200.00

Pin-Terminal

พินเทอร์มินอล

Size (sq.mm.)	Price ราคา
50	80.00
70	95.00
95	160.00
120	195.00
185	230.00

Full Tension Splice for ACSR Conductor

หลอดต่อสายอลูมิเนียมแกนเหล็กชนิดรับแรงดึง

Size (sq.mm.)	Length (mm.)	Price ราคา
35	350	120.00
50	440	180.00
70	480	240.00
95	500	810.00
120	500	990.00
150	520	โปรดสอบถาม
185	540	
240	660	
300	660	
400	660	
625	700	

Aluminum Compression Terminal Lug NEMA Hole

หางปลากลูมิเนียมเจาะรูตามมาตรฐาน นีมา

Size (sq.mm.)	Price / ราคา 1 Hole	Price / ราคา 2 Hole	Price / ราคา 4 Hole
25	โปรดสอบถาม	46.00	โปรดสอบถาม
35		48.00	
50		56.00	
70		72.00	
95		84.00	
120		135.00	
150		159.00	
185		168.00	
240		225.00	
300		800.00	
400	1,200.00		
625	1,800.00		

ALUMINUM CONNECTORS



Strain Clamp with Clamping Keeper

สเตรนแคลมป์ พร้อมแคลมป์บีงคิปปเปอร์

Size (sq.mm.)	Price ราคา
70-95	280.00
120	320.00
150	380.00
185-240	950.00
400	1,550.00
625	2,200.00

Strain Clamp Straight Type

สเตรนแคลมป์แบบตรง

Size (sq.mm.)		Price ราคา
AAC	ACSR	
35-70	35-70	180.00
95	70	290.00
120	95	330.00
150	120	380.00
185	150	420.00

PG Clamp Connector, Bolt Type

พีจี คอนเนคเตอร์

Size (sq.mm.)	Price / ราคา		Price / ราคา
	1 Bolt	2 Bolt	
16-70	26.00	35.00	-
25-95	30.00	40.00	-
70-185	-	-	110.00
95-240	-	-	146.00

Bimetallic P.G. Clamp Connector

พีจี แคลมป์ สำหรับใช้กับสาย AL/CU

Size (sq.mm.)	Price ราคา
CU-16/Al-70	90.00

Parallel Groove Clamp Connector

พีจี แคลมป์แบบมือเสือ

Size (sq.mm.)	Price / ราคาใน		Price / ราคานอก	
	1 Bolt		2 Bolt	
50-120	30.00	50.00	100.00	150.00
50-185	60.00	100.00	150.00	180.00

Dead End Connector

คอนเนคเตอร์เข้าปลายสาย

Size (sq.mm.)	Price ราคา
25-35	38.00
50-70	60.00
95-120	110.00

ALUMINUM CONNECTORS



Compression Connectors "H" Type

แคลมป์อลูมิเนียม เอชไทป์ ชนิดบีบี

Cat.No.	Size (sq.mm.)	Price ราคา
HF101	10-16/4-10	18.00
HF251	25-50/2.5-6	25.00
HF252	25-50/16-35	35.00
HF351	35-50/6-10	40.00
HF701	70-95/16-35	45.00
HF501	50-95/50-95	50.00

Hot Line Clamp

ฮอทไลน์ แคลมป์

Cat.No.	Size (sq.mm.)	Price ราคา
HL11	25-50	320.00
HL12	50-120	450.00
HL13	16-70 (MEA's Spec.)	430.00

Piercing Hotline Clamp

เพียซิ่ง ฮอทไลน์ แคลมป์

Insulation Thrickness	Cable Range	Price ราคา
Max.6 mm	Run 12.7-29 mm. Tap 4-1/0 AWG	850.00

Bail Clamp (Stirrup Clamp)

เบล แคลมป์

Cat.No.	Size (sq.mm.)	Price ราคา
HS21	25-50	400.00
HS22	70-185	550.00

Tie Wire

ลวดอลูมิเนียมกลม

Size (mm.)	Price ราคา / kg
4	280.00

Armour Tape

ลวดอลูมิเนียมแบน

Size	Price ราคา / kg
1x10 mm.	280.00

STEEL CROSSARM (HOT DIP GALVANIZED)



Crossarm Steel Channel

คอนเหล็กรูปร่างหน้า

Size (mm.)	Length (mm.)	Price ราคา
100x50x5	2500	2,300.00
125x65x6	2500	3,500.00
125x65x6	3000	4,200.00
100x50x5	4200	3,500.00
150x75x6.5	4000	8,000.00
150x75x6.5	4500	8,500.00
150x75x6.5	6000	11,000.00
200x80x7.5	1000	2,450.00
200x80x7.5	6000	14,500.00



Brace Steel Angel

คอนเหล็กฉาก

Size (mm.)	Length (mm.)	Price ราคา
65x65x6	1000	500.00
75x75x6	3500	3,000.00
75x75x6	4100	3,400.00
75x75x6	4500	3,600.00
100x100x7	4200	5,700.00
150x150x12	4500	12,600.00
150x150x12	5000	16,200.00



Steel Channel Alley Arm

คอนเหล็กท้าวแขนแบบรางหน้า

Size (mm.)	Length (mm.)	Price ราคา
100x50x5	2250	1,900.00



Brace Alley Arm

เหล็กท้าวแขนข้างเดียว

Size (mm.)	Length (mm.)	Price ราคา
40x40x5	2120	750.00
50x50x5	2350	1,080.00

HARDWARE & ACCESSORIES



Galvanized Ground Rod

กราวด์รูดชุบสังกะสี

Length (mm.)	Price / ราคา Size M-12	Price / ราคา Size M-16
1000	120.00	150.00
1500	130.00	180.00
1800	โปรดสอบถาม	250.00
2000	โปรดสอบถาม	280.00
2400	โปรดสอบถาม	320.00
3000	โปรดสอบถาม	420.00



Earthing Spike

กราวด์รูดสี่แฉก

Size (mm.)	Length (mm.)	Price ราคา
60x60x5	2,000	850.00



Brace Angel Steel

เหล็กหัวแขนแบบเขาควาง

Size (mm.)	Width (mm.)	Length (mm.)	Price ราคา
50x50x6	1500	450	990.00
50x50x6	1800	450	1,040.00



Overhead Ground Wire Bayonet

เหล็กโอเวอร์เฮด

Description	Price ราคา
Overhead bayonet 65x65x6 mm. 3,000 mm.	1,700.00
Corner bayonet 65x65x6 mm. 2,850 mm.	1,720.00
Overhead bayonet 65x65x6 mm. 2,500 mm.	1,390.00
Corner bayonet 65x65x6 mm. 2,150 mm.	1,400.00
Overhead bayonet 65x65x6 mm. 2,250 mm.	1,250.00
Corner bayonet 65x65x6 mm. 2,100 mm.	1,350.00
Dead - end bayonet 100x50x5 mm. 2,250 mm.	1,680.00
Dead - end bayonet 100x50x5 mm. 2,500 mm.	1,800.00

HARDWARE & ACCESSORIES



เหล็กคองเคเบิลอากาศทางตรง

Bracket aerial for straight type	Price
	ราคา
	800.00

เหล็กคองเคเบิลอากาศทางโค้ง

Bracket aerial for corner	Price
	ราคา
size 750 mm.	2,100.00
size 900 mm.	2,300.00
size 1000 mm.	2,400.00

เคเบิลสเปเซอร์สำหรับสายเคเบิลอากาศ

Type	Price
	ราคา
Polyethylene	480.00

เหล็กรับคานหม้อแปลง

Support transformer	Price
	ราคา
	1,580.00

อายันท์รู่นยนต์

Eye Nut Forged Type	Price
	ราคา
Size	
M 16	52.00
M 20	80.00

อายันท์รู่นเชื่อม

Eye Nut Welded Type	Price
	ราคา
Size (inch)	
5/8	42.00
3/4	60.00

แผ่นห่วงสำหรับสายยึดโยง 30 องศา

Angle guy attachment 30°	Price
	ราคา
	62.00

กายนทิมเบิลสำหรับสายยึดโยง 50-95 มม²

Guy thimble for steel wire 50-95 sq.mm.	Price
	ราคา
	12.00

ทิมเบิลเคลวิสสำหรับพรีฟอร์มเข้าปลายสาย

Thimble clevis Pin Diameter 16 mm.	Price
	ราคา
	80.00

D

HARDWARE & ACCESSORIES



Angle Bolt แฉงเกิลโบลท์

Size mm.	Price / ราคา M-16	Price / ราคา M-20	Price / ราคา M-24
130	60.00	โปรดสอบถาม	โปรดสอบถาม
150	65.00	โปรดสอบถาม	โปรดสอบถาม
170	68.00	โปรดสอบถาม	โปรดสอบถาม
200	70.00	90.00	โปรดสอบถาม
250	75.00	95.00	โปรดสอบถาม
300	80.00	98.00	โปรดสอบถาม
350	85.00	110.00	โปรดสอบถาม
400	90.00	120.00	โปรดสอบถาม
450	โปรดสอบถาม	โปรดสอบถาม	300.00
500	โปรดสอบถาม	โปรดสอบถาม	350.00
550	โปรดสอบถาม	โปรดสอบถาม	โปรดสอบถาม
600	โปรดสอบถาม	โปรดสอบถาม	โปรดสอบถาม

UNDERGROUND CABLE RACK & SUPPORT

Type	Price ราคา
UG Cable support type C	250.00
UG Cable rack 14 hole	450.00

แมนโฮลสเต็ป และ พูลลิ่งไอออน	Price ราคา
UG Cable pulling iron	300.00
Manhole step	300.00

โอเวอร์เฮด กราวด์ไวร์แคลม	Price ราคา
Ground wire support and clamp	
Type For bayonet	350.00
Type For concrete pole	380.00

โอเจแคลมป์	Price ราคา
Ground wire clam J-1152	50.00

กายแคลมป์ และ ห่วงแขวนสเปซอร์	Price ราคา
Guy clamp 1 bolt	85.00
Guy clamp 2 bolt	120.00
Guy clamp 3 bolt	140.00
Cable spacing	60.00

ยูแคลมป์ ซิงเกิ้ล และ ดับเบิล โบลท์	Price ราคา
Clamp single u-bolt M6 (5/16")	13.00
Clamp single u-bolt M8 (3/8")	15.00
Clamp single u-bolt M12 (1/2")	30.00
Clamp single u-bolt M16 (5/8")	45.00
Clamp double eye bolt M16 (5/8")	60.00

HARDWARE & ACCESSORIES



Double Arming Bolt

สลักเกลียวตลอด

Length / ความยาว		Price / ราคา Size 5/8"	Price / ราคา Size 24 mm.
inch	mm.		
12	300	75.00	-
14	350	80.00	-
16	400	87.00	-
18	450	95.00	-
20	500	105.00	-
22	550	110.00	-
24	600	118.00	350.00
26	650	125.00	370.00
32	800	-	390.00
40	1000	-	420.00
50	1250	-	600.00

*เกลียวหัวท้าย



Machine Bolt

สลักเกลียวอบสังกะสี

Length / ความยาว		Price / ราคา Size 1/2"	Price / ราคา Size 5/8"	Price / ราคา Size 3/4"
inch	mm.			
2	50	22.00	-	-
3	75	25.00	-	-
5	130	28.00	35.00	-
6	150	30.00	38.00	-
7	170	32.00	43.00	-
8	200	38.00	47.00	95.00
10	250	46.00	54.00	102.00
12	300	50.00	58.00	105.00
14	350	56.00	65.00	113.00
16	400	54.00	72.00	119.00
18	450	59.00	80.00	128.00
20	500	63.00	88.00	138.00
22	550	69.00	94.00	145.00
24	600	73.00	102.00	155.00
26	650	80.00	110.00	165.00
28	-	-	-	175.00

HARDWARE & ACCESSORIES



Angle Thimble Eye Bolt / สลักเกลียวห่วงหัวลิง 45 องศา (โค้ง)

Length / ความยาว		Price / ราคา	
inch	mm.	Size 5/8"	Size M16
6	150	100.00	93.00
8	200	108.00	102.00
10	250	116.00	109.00
12	300	125.00	117.00
14	350	136.00	129.00
16	400	145.00	139.00
18	450	150.00	โปรดสอบถาม
20	500	165.00	โปรดสอบถาม
22	550	178.00	โปรดสอบถาม
24	600	195.00	โปรดสอบถาม



Straight Thimble Eye Bolt / สลักเกลียวห่วงหัวลิง (ตรง)

Length / ความยาว		Price / ราคา
inch	mm.	Size 5/8"
6	150	88.00
8	200	99.00
10	250	110.00
12	300	120.00
14	350	130.00
16	400	140.00
18	450	150.00
20	500	โปรดสอบถาม
22	550	โปรดสอบถาม
24	600	โปรดสอบถาม



Anchor Rod (Welded Type) / สมอบกชนิดเชื่อม

Length / ความยาว / Feet (mm.)	5/8"	Price / ราคา	3/4"	Price / ราคา	M16	Price / ราคา	M20	Price / ราคา
5 (1500)	58005	370.00	34005	โปรดสอบถาม	161500	โปรดสอบถาม	201500	โปรดสอบถาม
6 (1800)	58006	390.00	34006	โปรดสอบถาม	161800	โปรดสอบถาม	201800	โปรดสอบถาม
7 (2000)	58007	420.00	34007	โปรดสอบถาม	162000	380.00	202000	โปรดสอบถาม
8 (2400)	58008	480.00	34008	โปรดสอบถาม	162100	450.00	202400	โปรดสอบถาม
10 (3000)	58010	580.00	34010	โปรดสอบถาม	163000	โปรดสอบถาม	203000	โปรดสอบถาม



Thimble Anchor Rod / สมอบกชนิด 1 ร่อง 2 ร่อง 3 ร่อง

Length / ความยาว / Feet (mm.)	1 ร่อง	Price / ราคา	1 ร่อง	Price / ราคา	2 ร่อง	Price / ราคา	3 ร่อง	Price / ราคา
	5/8"		M16		M20		M24	
5 (1500)	58005	โปรดสอบถาม	161500	โปรดสอบถาม	201500	โปรดสอบถาม	241500	โปรดสอบถาม
6 (1800)	58006	350.00	161600	โปรดสอบถาม	201600	โปรดสอบถาม	241800	โปรดสอบถาม
7 (2000)	58007	395.00	162000	โปรดสอบถาม	202000	โปรดสอบถาม	242000	โปรดสอบถาม
8 (2400)	58008	450.00	162400	โปรดสอบถาม	202500	590.00	242500	1,180.00
10 (3000)	58010	500.00	163000	โปรดสอบถาม	203000	โปรดสอบถาม	243000	โปรดสอบถาม

HARDWARE & ACCESSORIES



Eye Bolt

สลักหัววงกลม

Length ความยาว inch(mm.)	Size 5/8" Weld Type แบบเชื่อม	Price ราคา	Size M-16 Forged Type รุ่นย่น	Price ราคา
4(100)	-	-	160100	70.00
6(150)	58006	80.00	160150	80.00
8(200)	58008	88.00	160200	88.00
10(250)	58010	100.00	160250	100.00
12(300)	58012	108.00	160300	108.00
14(350)	58014	122.00	160350	122.00

Bolt Double Arming Round Eye

สลักหัวเกลียวตลอด

Length ความยาว inch(mm.)	Size 5/8" Weld Type แบบเชื่อม	Price ราคา	Size M-16 Forged Type รุ่นย่น	Price ราคา
16(400)	58016	125.00	160400	125.00
18(450)	58018	130.00	160450	130.00
20(500)	58020	135.00	160500	135.00
22(550)	58022	150.00	160550	150.00
24(600)	58024	160.00	160600	160.00
26(650)	58026	170.00	166500	170.00



Oval Eye Bolt

สลักหัวโอवल

Length ความยาว inch(mm.)	Size 5/8" Weld Type แบบเชื่อม	Price ราคา	Size M-16 Forged Type รุ่นย่น	Price ราคา
6(150)	160150	105.00	-	-
8(200)	160200	115.00	-	-
10(250)	160250	128.00	-	-
12(300)	160300	138.00	-	-
14(350)	160350	148.00	200350	198.00
16(400)	160400	165.00	2004000	270.00
18(450)	160450	170.00	200450	350.00
20(500)	160500	180.00	-	-
22(550)	160550	210.00	-	-
24(600)	160600	215.00	-	-

HARDWARE & ACCESSORIES

Hex. Nut

นัทหกเหลี่ยม

Hole inch	Hex. Type	Price ราคา
3/8	200110	7.00
1/2	200120	8.00
5/8	200160	10.00
3/4	200200	16.00
1	200240	30.00

Square Nut

นัทสี่เหลี่ยม

Hole inch	Square Type	Price ราคา
3/8	100110	7.00
1/2	100120	9.00
5/8	100160	10.00
3/4	100200	6.00
1	100240	28.00

Square Washer

แหวนสี่เหลี่ยม

Hole inch	Flat Type	Price ราคา
3/8	100011	7.00
1/2	100014	10.00
5/8	100018	12.00
3/4	100022	14.00
1	100026	22.00

Curve

แหวนสี่เหลี่ยมโค้ง

Hole inch	Curve Type	Price ราคา
1/2	200014	12.00
5/8	200018	14.00
3/4	200022	15.00
1	200026	30.00

Lock Washer

แหวนสปริง

Hole inch	Spring Type	Price ราคา
3/8	300011	7.00
1/2	300014	9.00
5/8	300018	10.00
3/4	300022	13.00
1	300026	17.00



Heavy Type Racks

แร็คช่องแนบการไฟฟ้า

Size	Thick 4 mm.	Price ราคา	Thick 5 mm.	Price ราคา
Rack 1 Spool	000041	โปรดสอบถาม	100051	70.00
Rack 2 Spool	000042		100053	180.00
Rack 3 Spool	000043		100055	270.00
Rack 4 Spool	000044		100057	380.00

Mounting Bracket

for Cutout & Lightning Arrester

ขาจับคัทเอาท์ และ ล้อฟ้า

Type	Price ราคา
Cross Arm	250.00

Mounting Bracket for Termination

ขาจับเทอมิเนชัน

Type	Price ราคา
Cross Arm	380.00

Pin for Insulator

ก้านลูกถ้วย

For Use with	Price ราคา
24 kV	300.00
33 kV	400.00
33 kV Fog Type	500.00

Flat Brace for Crossarm

เหล็กประกบกับไม้ค้อน

Size	Price ราคา
1 1/4" x 1/4" x 32"	82.00
1 1/4" x 1/4" x 36"	120.00
30 x 6 x 760 mm.	89.00
40 x 6 x 1000 m.	170.00

Anchor Plate

จานสมอบก

Size inch	Price ราคา
8	150.00
10	200.00
12	300.00

HARDWARE & ACCESSORIES



ANCHOR SHACKLE

DESCRIPTION	Price
	ราคา
M 16	400.00



TWISTED BOW SHACKLE

DESCRIPTION	Price
	ราคา
M 20	400.00



CLEVIS EYE

DESCRIPTION	Price
	ราคา
TYPE B	190.00



BALL CLEVIS

DESCRIPTION	Price
	ราคา
TYPE B	250.00
TYPE K	600.00



SOCKET EYE

DESCRIPTION	Price
	ราคา
35-240 MM ²	200.00
240-400 MM ²	220.00
400-625 MM ²	250.00



BALL Y-CLEVIS

DESCRIPTION	Price
	ราคา
TYPE J	300.00



BALL HOOK

DESCRIPTION	Price
	ราคา
TYPE B	190.00



BALL EYE

DESCRIPTION	Price
	ราคา
TYPE B	300.00



SOCKET CLEVIS

DESCRIPTION	Price
	ราคา
TYPE B	300.00
TYPE K	600.00



SOCKET Y-CLEVIS

DESCRIPTION	Price
	ราคา
TYPE J	380.00

D

HARDWARE & ACCESSORIES

Substation and Transmission Line Fittings upto 500 kV

Bolted Aluminum Connector



Bolted Bronze Connector



Compression Aluminum Connector



Welded Aluminum Connector



EHV Connector



ALUMINUM TUBE



HARDWARE & ACCESSORIES

Substation Supporting Structure



Take off double beam



Take off single beam



Earthing switch structure



Disconnecting switch structure



Surge arrester structure



CT structure



Bus support structure



Operating platform



LINEMAN TEST SET (ชุดตรวจแก้ไขโทรศัพท์)



Lineman Test Set (ชุดตรวจแก้ไขโทรศัพท์)

for installation, maintenance and connection to telephone lines.

Features:

- TALK / OFF / MONITOR switch
- DTMF / Pulse switch
- Last number redial in DTMF or PULSE (31digits)
- Polarity Test key - Visual indication LED red/green
- High Impedance Monitor (>120Kohm)

SPECIFICATION

Operating	Maximum operating temperature: -10C to +50C	
Protection against overvoltages	Transient suppressor 400V	
Power requirements	3V battery type CR1220 for memory storage. 9V battery type 6LR61 for monitor. Energy safe: in monitor power switch automatically off after approx. 5 mins. Low-level battery acoustical signal	
Detector for digital circuits	In OFF by live line (Voltage >66 VDC) MPG emits an acoustical warning signal	
	In ON by live line (Voltage >110 V) MPG lock users from going off-hook (talk)	
Cord length	Linear PVC flexible cord approx. 2.2meters c/w alligator clips	
Dimension (WxLxD)	70 x 195 x 75 mm	
Net Weight including cord	approx. 450 gr.	
Electrical	DC resistance in OFF	> 1 M & @ 50VDC (bridge 2x425)
	DC resistance in ON	< 300 & @ 50VDC
	Loop current	0 mA < loop current < 60mA
	MONITOR mode resist	> 120 k & nominal @ 1kHz
	Polarity check	< 8mA @ 50V
Pulse	Pulsing rate	10 pps typical
	Make / Break ratio	60 / 40
	Interdigit interval	800 ms typical
	Resistance during break	> 100k
DTMF	Frequency error	< +/- 1.5%
	Low / High level	-11dBV / -9dBV
	Tones on / off	> 65ms
	Tones pause	> 65ms (on request > 160ms)
	Earth break recall duration (FLASH)	100ms (on request 300 or 600ms)
Memory	Type	LNR, 10 memories
	Duration time	3 years for stored numbers
	Capacity	21 digits (31 digits LNR)
Transmission	Automatic gain control (Compensation for line impedance), electrete microphone capsule.	
Reception	Protected against acoustic shock, Automatic gain control (Compensation for line impedance), Dynamic receiver capsule, Receive level boost, +5,4 dB	
Price / ราคา	4,700.00	

TELEPHONE HARDWARE & ACCESSORIES



Sidewalk Guy Fitting Clamp

ไซค์วอลด์คิกาย

Type	Price ราคา
Pole Fitting	320.00
End Fitting	600.00

Thimble Eye Nut

ทิมเบิลอายนัท

Size (inch)	Price ราคา
5/8	80.00

Angel Thimble Eye

แองเกิลทิมเบิลอาย

Size (inch)	Price ราคา
5/8	90.00

Cable Extension Arm

เอ็กเท็นชันอาร์มเคเบิล

Type	Price ราคา
M1	175.00
M2	145.00
M3	230.00

Hook Bolt

ตะขอโทรศัพท์

Size (inch)	Price ราคา
3/8 x 8	50.00
3/8 x 10	55.00
3/8 x 12	60.00
3/8 x 14	65.00
1/2 x 12	90.00

Pole Bracket

แผ่นประกบเสา

Size (inch) with Stud	Price ราคา
8	77.00
10	87.00
12	98.00
14	112.00
20	145.00
Without Stud	
8	62.00
10	69.00
12	79.00
14	95.00
20	120.00

Cable Rack Extension

เคเบิลแร็คเอ็กซ์เทนชัน

Size (inch)	Price ราคา
-	60.00

Strandlink

สแตรนลิงค์

Type	Price ราคา
1/4	480.00
5/16	590.00
3/8	780.00



Cable Suspension Clamp

แคลมป์จับสายโทรศัพท์

Type	Price ราคา
1 Bolt	55.00
3 Bolt	90.00
Curver	110.00

Cable Clamp

แคลมป์จับสายโทรศัพท์

Type	Price ราคา
PA 296	100.00

Strand Ground Clamp

สแตรนด์กราวด์แคลมป์

Type	Price ราคา
1/2	30.00

Cable Lashing Clamp

แลชชิงแคลมป์

Type	Price ราคา
D	15.00

Span Clamp Type E

อินชูละทสแนมแคลมป์ไทป์ อี

Type	Price ราคา
E	35.00

Span Clamps Type C

สแนมแคลมป์ไทป์ ซี

Type	Price ราคา
C	25.00

Galvanize Steel Clamp

แคลมป์กราวด์รีด

Size (inch)	Price ราคา
1/2	25.00
5/8	35.00

Cable Rack

เคเบิลแร็ค

Type	Price ราคา
8 Hole	100.00
14 Hole	145.00
18 Hole	160.00

Cable Rack Hook

เคเบิลแร็คฮุก

Size (inch)	Price ราคา
7 1/2	60.00
10	90.00
14	120.00

Strandvise

สแตรนด์ไวซ์

Size (inch)	Price ราคา
1/4	630.00
5/16	680.00
3/8	980.00

TELEPHONE HARDWARE & ACCESSORIES



Station Wire Crip สแตชันไวร์คริป

Price / ราคา
2.00

Drop Wire Crip ดรอพไวร์คริป

Price / ราคา
2.00

Stainless Steel Band สแตนเลสสตีลแบนด์

Width (inch)	Length (m.)	Price ราคา
1/2	30	420.00
3/4	30	480.00

Cable Lashing Wire ลวดเลashingไวร์

O.D. (inch)	Length (Ft.)	Price ราคา
0.045	1200	1,800.00

Telephone Arrester ล่อฟ้าโทรศัพท์

Type	Price / ราคา
Gas Tube	150.00

Ready Access ตู้เรดดี

Type	Price / ราคา
100 MB	1,350.00
100 MBY	1,470.00
200 MB	1,875.00
200 MBY	1,950.00

Sealing Tape ซีลลึงเทป

Size	Price / ราคา
No. 1	โปรดสอบถาม
No. 2	
No. 3	
No. 4	

Aluminum Tape เทปอลูมิเนียม

Size (inch)	Length (Ft.)	Price ราคา
2	3	80.00
4	19	160.00

Acid-Core Solder ตะกั่วบัตกรี

Type 40/60 dia.	Price / ราคา
1.59	โปรดสอบถาม
2.4	
3.2	
Bar	

"DR" Tape ดี อาร์ เทป

Size (inch)	Length (Ft.)	Price ราคา
3/4" x 0.45"	15	160.00
2" x 0.45"	15	220.00



Drop Wire Clamp ดรอพไวร์แคลมป์

Price / ราคา
15.00

Plastic Drive Ring พลาสติกไดรฟ์ริง

Price / ราคา
2.50

Stainless Steel Buckle หัวเข็มขัด

Size (inch)	Price / ราคา
1/2	10.00
3/4	15.00

Plastic Cable Spacer พลาสติกเคเบิลสเปซเซอร์

Size (inch)	Price / ราคา
1/4	2.80
1/2	3.80
3/4	5.00
1	8.00

Cable Support เคเบิลซัพพอร์ต

Size (inch)	Price / ราคา
3/4 x 8	9.00
3/4 x 10	10.00
3/4 x 12	12.00
3/4 x 14	14.00
3/4 x 16	16.00
3/4 x 20	18.00
3/4 x 22	20.00
3/4 x 26	26.00
3/4 x 28	30.00

Terminal Six Pairs เทอร์มินอลหกคู่สาย

Size (inch)	Price / ราคา
6P	120.00

Terminal Blocks 25 Pairs สตัปเทอร์มินอลบล็อก 25 คู่สาย

Size (inch)	Price / ราคา
25P	1,000.00

Stub Cable Terminal สตัปเคเบิลเทอร์มินอล

Size	Price / ราคา
11 C	1,200.00
16 C	1,850.00
26 C	3,600.00

"PVC" Tape พีวีซี เทป

Size (inch)	Length (m.)	Price / ราคา
3/4	20	30.00
2	20	60.00

Glass Tape กลาสเทป

Size (mm.)	Length (m.)	Price / ราคา
38	30	350.00
50	30	380.00

TELEPHONE HARDWARE & ACCESSORIES



Wiring Tackers
ปืนยิงสายโทรศัพท์

Staper
ลูกปืนยิงสายโทรศัพท์

Cat. No. ART-	Price ราคา	Cat. No. ARS-	Size (inch)	Price ราคา
T-18	3,500.00	T-18-3/8	3/16-3/8	170.00
T-25	3,500.00	T-18-7/16	3/16-7/16	170.00
T-75	3,500.00	T-25-3/8	1/4-3/8	170.00
		T-25-7/16	1/4-7/16	170.00
		T-75-5/8	1/2-5/8	350.00
		T-75-9/16	1/2-9/16	350.00



Guy Guard
เหล็กครอบสายกาย

Cat. No. FGC-	Size (ft.)	Price / ราคา
00007	7	1,200.00



Screw Anchor Rod
สหมอบก แบบสกรู

Cat. No. SWA-	Size (ft.)	Price / ราคา
09030	8	3,000.00
09040	12	3,400.00
09050	15	3,850.00



Plastic Sleeve
พลาสติกห่อตัดต่อสาย

Cat. No. SWA-	Size (mm.)		Price / ราคา(ห่อ)
00018	0.5x2.7x76	Green	130
00028	0.65,0.9x3.2x76	Black	
00038	0.65,0.9x3.8x76	Red	
00110	0.4x2.5x76	Blue	
00211	0.4x1.9x50	Blue	
00311	0.5x2.3x50	Red	
00411	0.65x2.9x50	Blue	
00511	0.9x4.3x50	Red	



Strapping Band Clamp Tool
แบนด์แคลมป์ทูล

Cat. No. SWA-	Size (inch)	Price ราคา
03834	3/8-3/4	6,500.00



Lasher Machine

Cat. No. GMP-	Price / ราคา
J2	230,000.00
C	150,000.00

C-CABLE LASHER For cable to 1.7" on strands 1/4" to 3/8" wh.49 lbs.
J2 CABLE LASHER For cable to 3" on strand 1/4" to 7/16"
THIS MACHINE HAS OVERLASHING Capability with the turn of a liver wh. 65 lbs.



CR Tape
ซีอาร์ เทป

Cat. No. CR-	Size	Price / ราคา
28	28" x 0.050" x 20"	13,500.00



Flat Crossarm Brace
ประกับไม้ค้อน

Cat. No. HFB-	Size (inch)	Price / ราคา
05070	³ / ₁₆ x 1 ¹ / ₄ x 30	100.00
05090	³ / ₁₆ x 1 ¹ / ₄ x 36	120.00
05110	³ / ₁₆ x 1 ¹ / ₄ x 42	100.00

GROUP E

TOOLS, HYDRAULIC TOOLS & SAFETY TOOLS



VOLTAGE DETECTOR (เครื่องตรวจสอบแรงดันไฟฟ้า)

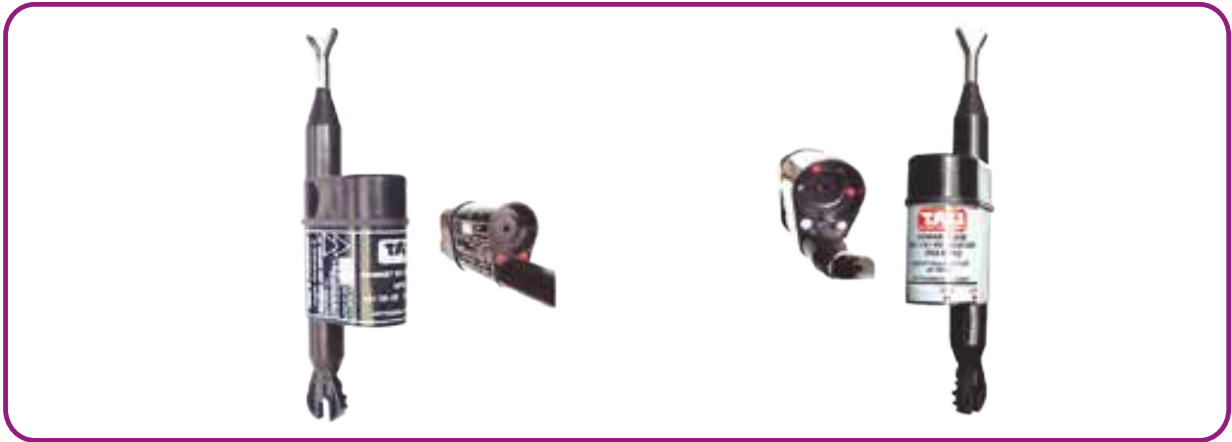

Voltage Detector

Voltage detector attachable to hot stick. They indicate the presence/absence of voltage in installations of medium and high voltage. They do not possess keys, switches or movable parts. Adaptable to any kind of hot stick.

Detail	Cat. No.**			
	DPM-5-15	DPM-10-35	DPM-5-33	DPM-MR
Type	Single range			Multi range
Voltage Range (kV)*	5-15	10-35	5-35	0.6, 2, 7, 11
Indication	Acoustic and luminous signal of high intensity			
Power Supply	9 V Battery			
Use	Indoor/Outdoor			
Standard	Complies to IEC 61243-1			
Accessories	Incorporated tester to check the correct mechanical and electronic function			

Note: * Other voltage range required please consult factory

** Add suffix H or U or T to Cat. No. for selection of splice type

H : Hexagon splice type

U : Universal splice type

T : Ratchet splice type

FIBERGLASS TELESCOPING UNIVERSAL STICK

- Meet with ASTM F71 for Rod and Tube used in Live Line Tools
- Withstrand voltage 100 kV / foot / 5 minutes
- With universal hook and carrying bag



Telescoping Disconnect Tools Standard Duty (1¹/₁₆" - dia. Tip)

Cat. No.	Extended Length ft. (Tool can be locked at each length shown)	Storage Retracted Length inch	Base Dia. inch	Number of Sections	Price ราคา
C403-1020	16 ¹ / ₂ - 20 ¹ / ₂ -25	63	2 ¹ / ₁₆	6	22,000.00
C403-1021	17 ¹ / ₂ - 21 ¹ / ₂ - 25 ¹ / ₂ - 30	65	2 ¹ / ₄	7	27,000.00
C403-1022	22 - 26 - 30 ¹ / ₂ - 35	67	2 ¹ / ₂	8	33,000.00

DISCONNECT STICKS (ໄມ້ຫັກປົວສ໌)



Used on Cutouts, Disconnect Switches

Disconnect sticks provide insulation safety for linemen in opening and closing disconnect switches and cutouts. They are also used for installing and removing open-link fuse links. Poles are made of Epoxiglas NEMA standard heads of cast bronze for using with switch head, disconnect head, or spliced disconnect head.

Spliced Disconnect Sticks

For convenience in transporting and/or where greater length is required, Spliced Disconnect Sticks are available, the splice is strong and rigid...easy to put together and easy to take apart. The taking-down feature of these sticks makes them especially handy to carry on line trucks or in tool trailers.

Cat. No.	Pole Dia. and Length	Piece	Price / ກີດາ
130500-8-1	1 ¹ / ₄ " x 8'	1	7,500
130500-12-1	1 ¹ / ₄ " x 12'	1	9,500
130500-16-2	1 ¹ / ₄ " x 8' and 1 ¹ / ₂ x 8'	2	14,500
130500-18-2	1 ¹ / ₄ " x 8' and 1 ¹ / ₂ x 10'	2	16,500
130500-20-2	1 ¹ / ₄ " x 10' and 1 ¹ / ₂ x 10'	2	18,500
130500-24-2	1 ¹ / ₄ " x 12' and 1 ¹ / ₂ x 12'	2	21,000
130500-24-3	2 pc of 1 ¹ / ₄ " x 8' and 1 pc of 1 ¹ / ₂ x 8'	3	21,000



Shortgun Clampstick

Shortgun clampstick with external operating rod, made by Fiberglass foam filled yellow pole, conforming to ASTM & OSHA standard tested to 100 kV/foot/5 minutes
Single Piece Style

Cat. No.	Pole Dia. and Length	Price / ກີດາ
8106	1 ¹ / ₄ " x 6'6"	14,000
8108	1 ¹ / ₄ " x 8'6"	16,500
8112	1 ¹ / ₄ " x 12'6"	20,000



Hinged Style

Cat. No.	Pole Dia. and Length	Price / ກີດາ
13412	1 ¹ / ₄ " x 6'6"	25,000
13413	1 ¹ / ₄ " x 8'6"	29,000
13414	1 ¹ / ₄ " x 10'6"	31,000
13415	1 ¹ / ₄ " x 12'6"	34,100



Fit-on Pole Universal Heads

Cat. No.	Pole Dia.	Length	Price / ກີດາ
130512	1-1/4"	16ft. (2x8ft.)	8,250
130514	1-1/4"	24ft. (2x12ft.)	9,000

Other length is also available upon request.

CONDUCTORS, INSULATORS & POLE COVERS (ชุดครอบสายไฟฟ้า, ลูกถ้วยไฟฟ้า และเสาไฟฟ้า)



Conductor Cover

Cat. No.	Rated	Length	Price / ราคา
C406-0181GA	25kV phase to phase	5 ft.	15,000.00
C406-0514GA	36.6kV phase to phase	5 ft.	17,000.00
12000	72.5kV phase to phase	4 ft. 6"	25,000.00



SINGLE AND DOUBLE INSULATOR COVER

- : For used with pin type insulators
- : 1 or 2 insulators
- : Fitted with conductor cover

Cat. No.	Type	Price / ราคา
C4060182	25 kV Insulator Cover - 6" with Grip all Adapter	12,000.00
C4060557	36.6 kV Insulator Cover - 12" with Grip all Adapter	17,000.00
C4060046	46 kV Insulator Cover through 10 ¹ / ₂ " diameter, Lenght 22" to 34"	22,000.00



POLE COVER

- Pole Dia. : Up to 9 to 12 inch
- Rated kV : 36.6 kV Phase-to-Phase

Cat. No.	Diameter Pole Cover	Length (inch)	Price / ราคา
C406 - 0000	12"	6 ft. (72")	33,600.00
M4937 - 4	9"	4 ft. (48")	24,000.00

RUBBER INSULATING GLOVES, BLANKETS AND GROUNDING UNIT (ถุงมือกันไฟฟ้า, ผ้าท่มยาง และชุดชอร์ตกราวด์)

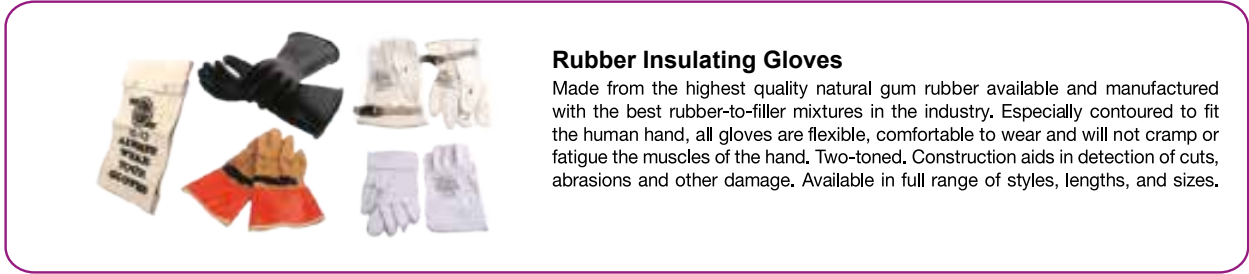

Rubber Insulating Gloves

Made from the highest quality natural gum rubber available and manufactured with the best rubber-to-filler mixtures in the industry. Especially contoured to fit the human hand, all gloves are flexible, comfortable to wear and will not cramp or fatigue the muscles of the hand. Two-toned. Construction aids in detection of cuts, abrasions and other damage. Available in full range of styles, lengths, and sizes.

Cat. No.	Glove Length	Proof Test Voltage (kV)	Material	ASTM Class	Colour	Price ราคา
E011R/9	11"	5/20	Rubber	0	Red	6,600.00
E114B/9	14"	10/40	Rubber	1	Black	9,000.00
E214B/9	14"	20/50	Rubber	2	Black	15,000.00
E314B/9	14"	30/60	Rubber	3	Black	19,000.00
E416B/9	16"	40/70	Rubber	4	Black	30,000.00
ILP10	10"	Use on glove class	Leather	0	White	3,600.00
ILP3S	12"		Leather	1 to 4	Brown	5,000.00
#35-12	9 x 14	Heavy Duty	Glove bags	-	-	3,000.00
#40	8 x 14		Tool Bucket	-	-	8,000.00



Rubber Insulating Blanket



Blanket Pin

Rubber Insulating Blanket

The insulating Blanket is a versatile cover up device best suited for protection against accidental contact of line man's body to the energized equipment on pole when working.

Cat. No.	Rated (kv)	Type	Size (inch)	Price ราคา
VB4-3636	36	6 eyelets	36 X 36 X 1/8	24,000.00
Blanket Pin for Insulating Blanket				
VC-2S	Standard spring clamp with jaw opening upto 5"			800.00



Short ground

Temporary Grounding Equipment / Shorting Unit

Shorting set Clamps and accessories to ground distribution or transmission lines while carrying out maintenance work

Rated (kv)	Size (sq.mm.)	Price ราคา
22	35 - 120	49,000.00
33	70 - 240	59,000.00
115	240 - 400	120,000.00

SAFETY BELT - POLE STRAP (เข็มขัดป็นเสานิรภัย / สายกันตก)



SAFETY BELT (เข็มขัดนิรภัย)

เข็มขัดป็นเสานิรภัย ชนิดมีเบาะรองรับแรง และห่วง D-ring สำหรับใช้คู่กับ แถบสายคล้องเสา (Pole Strap) ห่วง D-ring ผลิตจากเหล็กชั้นดี มีความแข็งแรง ได้มาตรฐาน เบาะรองรับผลิตจากหนังชั้นดี คงทน มีความยืดหยุ่น สวมใส่สบาย มีสายสำหรับใส่เครื่องมือครบครัน

Cat. No.	D-Size	Price / ราคา
GK-SB01	20"	6,500.00
GK-SB02	22"	7,000.00



POLE STRAP (สายกันตก)

แถบคล้องเสาหรือสายกันตกชนิดปรับความยาวด้วยหัวเข็มขัด สำหรับใช้คู่กับ SAFETY BELT ผลิตจากเส้นใยชนิดพิเศษ สามารถรับแรงดึงได้สูง พร้อมทั้ง Red warning Tap อยู่ชั้นกลางเพื่อเตือนผู้ใช้งาน ตะขอผลิตจากเหล็กกล้าชั้นดีโดยวิธี Forged ผ่านกรรมวิธีชุบกันสนิมที่ได้มาตรฐาน

Cat. No.	Size	Price / ราคา
GK-1700	1700 mm	6,000.00
GK-2 00	2000 mm	6,500.00

PAT NBK CO.,LTD

HARU SAFETY BELTS (เข็มขัดป็นเสา)



HARU Safety Belt Model HC - 27

Specification

- a) Safety belt Nylon safety belt with buckle, length 1200 mm. width 46 mm.
- b) Body Belt Nylon body belt with one of "E" ring and two "D" ring, length 700 mm. width 75 mm.
- c) Life rope Nylon life rope with rope adjuster and snap hook No. HC - 27 length 2200 mm. dia 16 mm.
- d) Tensile strength : 1200 kg.

Price / ราคา
3,000.00

HARU Safety Belt Model HC - 113

Specification

- a) Safety belt Nylon safety belt with buckle, 5 Tool loops, length 1200 mm. width 46 mm.
- b) Body Belt Body cushion made from nylon and leather with Knife snap, Glove bag ring, Tape sling. One "E" ring and one "D" ring,
- c) Life rope Nylon life rope with rope adjuster, snap hook No.113 and "B" ring. length 2200 mm. dia 16 mm.
- d) Tensile strength : 1500 kg.

Price / ราคา
4,800.00

- Life rope Nylon life rope with rope adjuster, snap hook No.113 and "B" ring. Length 2000 mm. dia 16 mm.

Price / ราคา
2,200.00

SAFETY TOOLS



Safety Cap & Tie

หมวกนิรภัย และ สายรัดคาง

Color	Price / ราคา
White, Yellow, Blue, Green and Orange	
Safety Cap	750.00
Tie	250.00

Safety Shoes

รองเท้าเซฟตี้ หัวเสริมเหล็กหุ้มข้อ

Size	Price / ราคา
#6(40), 7(41), 8(42), 9(43), 10(44), 11(45)	1,500.00

Pole Step & Belt

ขาปีนเสา และ เข็มขัดรัดรองเท้า

Type	Price / ราคา
Concrete Pole	
Pole Step	600.00
Belt	350.00

Cable Block

รอกพาดสาย และ รอกส่งเครื่องมือ

Type	Price / ราคา
Cross Arm & String	3,200.00
303 String	2,100.00
OPGW Stringing Block 3ton	18,000.00

Cable Block

รอกพาดสายโทรลล์พท์

Type	Price / ราคา
String	720.00
String Wire Lock	900.00

Traffic Vest

เสื้อจราจรสะท้อนแสง

Type	Price / ราคา
Nylon A	800.00
Nylon B (มี Screen ตัวหนังสือ)	1,200.00

RATCHET LEVER HOIST

Ratchet lever hoist

Capacity 750-6,000kg
Features:

- Forged suspension and load hook from non-aging, high alloy tempering steel, yield under overload instead of breaking
- Chain guide is integrated into the housing to eliminate fouling and jamming of the chain on the load sheave.
- Robust chain stop
- Handlever with rubber grip
- Hard Chromium plated hand wheel
- Sturdy bottom block with encapsulated bolt connections.

Technical data

Model	Capacity (kg)	No. of Chain falls	Chain dimension d x p (mm)	Lift with one full lever turn (mm)	Handle pull at WLL (daN)	N.W. (kg)	Price / บาท
Uno 750	750	1	6 x 18	20	14	7	โปรดสอบถาม
Uno 1500	1500	1	8 x 24	22	22	11	โปรดสอบถาม
Uno 3000	3000	1	10 x 30	17	34	21	โปรดสอบถาม
Uno 6000	6000	2	10 x 30	9	35	30	โปรดสอบถาม

Dimensions

Model	Uno 750	Uno 1500	Uno 3000	Uno 6000
A min (mm)	295	380	420	570
B (mm)	21	29	37	54
C (mm)	24	32	35	44
D (mm)	13	20	24	43
E (mm)	235	350	350	350
F (mm)	111	140	174	239
G (mm)	33	49	60	77
H (mm)	78	91	114	162
J (mm)	142	166	184	184
K (mm)	55	66	79	79
L (mm)	87	100	105	105

Trade Master / Taiwan

CABLE RATCHET PULLING SET (ชุดรatchetดึงสาย)

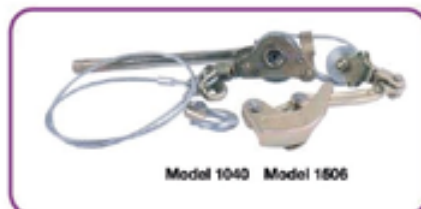

Model	Capacity	Wire rope	Rope L.	Lever L.	Wire Grip	WT.	Price / บาท
1040	1 ton	5 mm	2200 mm	330 mm	2 ton grip	4.3 kg	9,200.00
1506	1.5 ton	6 mm	2200 mm	340 mm	2 ton grip	5.6 kg	11,000.00
2000	2 ton	5 mm	2200 mm	430 mm	Snap hook	4.2 kg	12,500.00

Trade Master

CABLE PULLING GRIPS (ตาข่ายลากสาย)

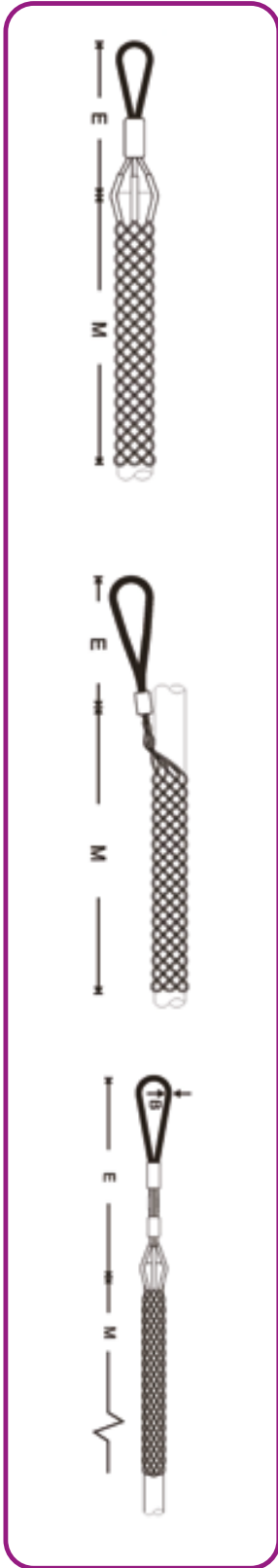

PULLING GRIPS

- For medium load cable
- Double weave, Rotating eye

Model No.	Cable Dia	Breaking load	E	M	Price / ๖๓๓
TG-050-24	10-15 mm	2040 kg	200 mm	300 mm	1,100.00
TG-062-24	15-18 mm	2540 kg	200 mm	500 mm	1,400.00
TG-075-24	18-25 mm	3080 kg	230 mm	550 mm	1,800.00
TG-100-24	25-37 mm	4350 kg	230 mm	600 mm	2,150.00
TG-150-24	37-50 mm	7440 kg	280 mm	650 mm	2,700.00
TG-200-24	50-63 mm	8390 kg	300 mm	700 mm	3,000.00
TG-250-24	63-75 mm	11110 kg	300 mm	750 mm	4,200.00
TG-300-24	75-88 mm	11110 kg	350 mm	800 mm	4,800.00
TG-350-24	89-102 mm	14060 kg	350 mm	800 mm	5,400.00

SLACK GRIPS

- Split mesh lace closing
- Double weave, Offset flexible eye

Model No.	Cable Dia	Breaking load	E	M	Price / ๖๓๓
SG - 075 A	18-25 mm	1130 kg	127 mm	279 mm	2,100.00
SG - 100 A	25-32 mm	1590 kg	127 mm	279 mm	2,450.00
SG - 125 A	32-37 mm	1810 kg	152 mm	406 mm	2,800.00
SG - 150 A	37-50 mm	1810 kg	229 mm	432 mm	3,200.00
SG - 200 A	50-63 mm	1810 kg	254 mm	483 mm	4,000.00
SG - 250 A	63-75 mm	1810 kg	305 mm	508 mm	4,200.00
SG - 300 A	75-88 mm	1810 kg	305 mm	533 mm	4,500.00
SG - 350 A	88-102 mm	1810 kg	305 mm	599 mm	4,800.00

Pulling Grip

- High strength of cable and overhead transmission line construction
- A.C.S.R, A.C.A.R, Cu&Al conductor and ground wires
- Triple Weave Galvanized Wire, Single eye

Model No.	Cable Dia	Breaking load	E	M		Price / ๖๓๓
D-10	4.84-9.40 mm	2948 kg	250 mm	250 mm	6.4 mm	3,000.00
D-16	9.60-16.0 mm	6350 kg	300 mm	300 mm	10 mm	3,500.00
D-22	16.0-22.1 mm	9072 kg	325 mm	325 mm	10 mm	4,600.00
D-28	22.4-28.4 mm	13880 kg	375 mm	375 mm	13 mm	6,500.00
D-35	29.0-32.9 mm	21228 kg	450 mm	450 mm	16 mm	8,500.00
D-48	35.0-48.3 mm	30146 kg	600 mm	600 mm	20 mm	9,900.00

BRYANT

ECONOMY CABLE GRIP / USA



PULLING - HEAVY - DUTY MULTIPLE STRENGTH FLEXIBLE EYE Features - Specification

- : Triples weave for greater gripping power: High strength galvanized steel
- : Endless weave will not snag lies flat on cable
- : Longer-wearing, reinforced tubular shoulder protect cable ends

Pulling Grips Type FE

Model No.	Cable Range O.D.(Inch)	Breaking in lbs.	E inch	M inch	Price / ราคา
MST025FE	1/4 - 3/8	6800	9	26	6,000.00
MST050FE	1/2 - 5/8	10000	9	32	7,200.00
MST075FE	3/4-1	10100	11	41	9,500.00
MST100FE	1-1 1/4	21000	12	52	11,100.00
MST125FE	1 1/4- 1 3/4	21000	12	56	12,500.00
MST150FE	1 1/2- 1 3/4	22500	18	60	โปรดสอบถาม
MST175FE	1 3/4 - 2	22500	18	70	โปรดสอบถาม

PULLING - SPLICING FLEXIBLE TUBES WIRE WOVEN Features - Specification

- : Double weave mesh construction : High - strength galvanized steel
- : Easy installation and removal : Reusable

Pulling - Splicing Type FTD

Model No.	Cable Range O.D.		Breaking in lbs.	Mesh length (L)		Price / ราคา
	inch	mm.		inch	mm.	
FTD03718	.37-.49	9.4-12.4	3500	18	457.2	4,200.00
FTD05024	.50-.61	12.7-15.5	3500	24	609.6	4,800.00
FTD06236	.62-.64	15.7-18.8	4400	36	914.4	5,800.00
FTD07548	.75-.99	19-25.1	7500	48	1219.2	6,600.00
FTD10048	1-1.49	25.4-37.8	10000	48	1219.2	9,000.00
FTD15048	1.5-1.99	38.1-50.5	16000	48	1219.2	โปรดสอบถาม

SUPPORT GRIPS / ตาข่ายทิวสาย

Type U (Single eye)

ตาข่ายทิวสายชนิดหูเดียว

Cable Range O.D.		Breaking in lbs.	E inch	M inch	Price / ราคา
Min.	Max.				
1/2	5/8	530	4	10	1,200.00
5/8	3/4	1020	4	13	1,500.00
1	1 1/4	1610	5	14	1,700.00
1 1/2	1 3/4	1610	5	17	2,100.00
1 3/4	2	1610	6	19	2,600.00
2	2 1/2	3260	6	21	3,100.00
2 1/2	3	3260	6	23	3,600.00
3	3 1/2	4900	8	25	5,500.00
3 1/2	4	4900	8	27	5,900.00

Type DE (Double eye)

ตาข่ายทิวสายชนิดสองหู

Cable Range O.D.		Breaking in lbs.	E inch	M inch	Price / ราคา
Min.	Max.				
1/2	5/8	530	4	10	1,200.00
5/8	3/4	1020	4	13	1,500.00
1	1 1/4	1610	5	14	1,700.00
1 1/2	1 3/4	1610	5	17	2,100.00
1 3/4	2	1610	6	19	2,600.00
2	2 1/2	3260	6	21	3,100.00
2 1/2	3	3260	6	23	3,600.00
3	3 1/2	4900	8	25	5,500.00
3 1/2	4	4900	8	27	5,900.00

Type U (Single eye)

ตาข่ายทิวสายชนิดผ่าข้างหูเดียว

Cable Range O.D.		Breaking in lbs.	E inch	M inch	Price / ราคา
Min.	Max.				
5/8	3/4	1020	4	13	1,800.00
1	1 1/4	1610	5	14	2,000.00
1 1/2	1 3/4	1610	5	17	2,400.00
1 3/4	2	1610	6	19	2,700.00
2	2 1/2	3260	6	21	3,100.00
2 1/2	3	3260	6	23	3,800.00
3	3 1/2	4900	8	25	5,800.00
3 1/2	4	4900	8	27	6,200.00

Type DE (Double eye)

ตาข่ายทิวสายชนิดผ่าข้างสองหู

Cable Range O.D.		Breaking in lbs.	E inch	M inch	Price / ราคา
Min.	Max.				
5/8	3/4	1020	4	13	1,800.00
1	1 1/4	1610	5	14	2,000.00
1 1/2	1 3/4	1610	5	17	2,400.00
1 3/4	2	1610	6	19	2,700.00
2	2 1/2	3260	6	21	3,100.00
2 1/2	3	3260	6	23	3,800.00
3	3 1/2	4900	8	25	5,800.00
3 1/2	4	4900	8	27	6,200.00

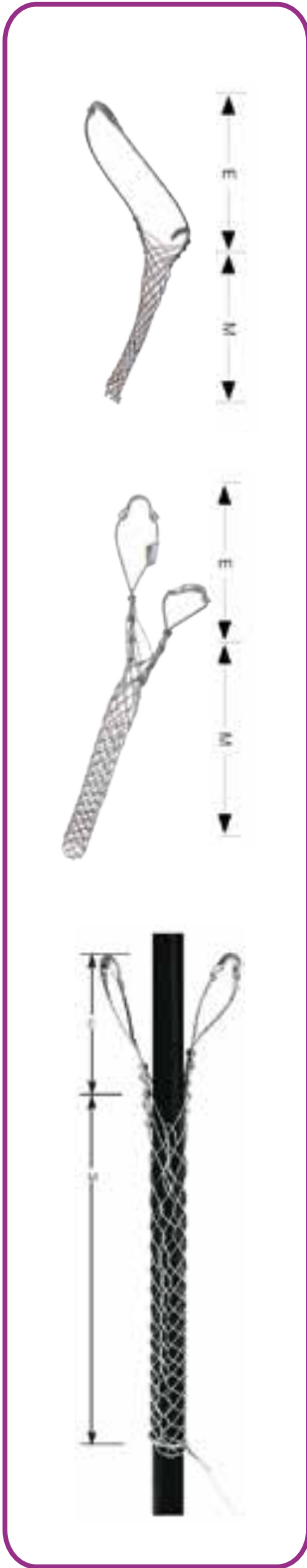

WIRE GRIP (แคล้มปีดิ่งสาย)



PULLING SWIVEL

GRIPS FOR BARE ACSR, AAC AND STRANDED COPPER CABLE

1 TON WIRE GRIP FOR COPPER BARE & STEEL MESSENGER WIRE

2 TON WIRE GRIP FOR COVERED CONDUCTOR

3 TON WIRE GRIP FOR COVERED CONDUCTOR

EYE HOOK

Trade Master

Wire Grips (แคล้มปีดิ่งสาย)

- * Prevent winding and tangling during pull
- * Must not pass through bull wheel on puller
- * Select the swivel with a suitable working load
- * safety factor of 3:1 for horizontal pull only

Light Duty swivel

พูลลิ่งสไวเวล

Model	Breaking load	A	B	C	Weight	Price / ราคา
HGS-3000	3 ton	90 mm	24 mm	12 mm	0.35 Kg	3,200.00
HGS-3500	4.5 ton	105 mm	36 mm	20 mm	0.47 Kg	3,750.00
HGS-5000	7.2 ton	140 mm	30 mm	13 mm	0.60 Kg	4,300.00
HGS-8000	12 ton	150 mm	38 mm	16 mm	1 Kg	4,725.00

Wire Grips

- * for Bare A.C.S.R., Aluminum cable and stranded-copper cable
- * Max.coverage of cables will minimized damage of conductors

Model	Safe load	Min Cable Dia.	Max Cable Dia.	Jaw L.	Weight	Price / ราคา
1656-20	2 ton	5.08 mm	10.16 mm	105 mm	1.36 kg	4,725.00
1656-30	2 ton	7.87 mm	13.46 mm	121 mm	1.70 kg	5,060.00
1656-40	3.6 ton	13.48 mm	18.80 mm	140 mm	3.4 kg	5,850.00
1656-50	3.6 ton	18.04 mm	21.83 mm	140 mm	3.4 kg	6,750.00
1656-60	3.6 ton	21.83 mm	24.60 mm	140 mm	3.4 kg	โปรดสอบถาม
1656-70	3.6 ton	24.36 mm	25.91 mm	140 mm	3.4 kg	โปรดสอบถาม

SD-GRIP

Model SD-1000C * For copper cable,covered conductor,steel rod,copper cable and messenger wire

Safe load	Min Cable Dia.	Max Cable Dia.	Weight	Price / ราคา
1 ton	2.6 mm	15 mm	0.6 kg	3,150.00

2 Ton Grip

Model S-2000C * For bare copper,messenger wire and covered conductor

Safe load	Min Cable Dia.	Max Cable Dia.	Weight	Price / ราคา
2 ton	4 mm	22 mm	1.2 kg	4,600.00

3 Ton L-Grip

Model S-3000CL * For copper cable,covered conductor and messenger wire

Safe load	Min Cable Dia.	Max Cable Dia.	Weight	Price / ราคา
3 ton	16 mm	32 mm	2.8 kg	9,000.00

Eye Hook

ตะขอเกี่ยวพร้อมแคปสี่ก

Model	H-1500TH with cap		Weight (kg)	Price / ราคา
	Safe load (kg)	Eye mm. / Jaw mm.		
1,500	16	21	0.25	600.00

**WIRE GRIP (แคลมป์ดึงสาย)
CABLE CUTTER & CABLE STRIPPER
(คีมตัดสายเคเบิล & เครื่องลอกสายเคเบิล)**



KLEIN
Grips for Large Diameter Conductors

Model	Conductor sq.mm.		Price
	ACSR	AAC	ราคา
1628-30	240-400	300-500	35,000.00
1628-40	500-625	625-800	38,000.00



KLEIN
Grips for PVC Covered Conductors

Model	Conductor sq.mm.	Price
		ราคา
1659-20	10-25	4,800.00
1659-30	16-50	5,200.00
1659-40	70-120	6,500.00
1659-50	150-240	8,000.00



H.K Porter
Ratchet type, Hard Cable Cutter
for AAC, ACSR, Copper cable, Telephone cable, Steel Stranded wire

Type	Cutting Capacity Max.Dia.mm.	Length mm.	Price
			ราคา
8690 FH	30	743	32,000.00

H.K.P. CABLE CUTTER



**Shearing type cable cutter for AAC
Copper Conductors**

Model	Max.Conductor Size sq.mm.	Body Length mm.	Price
			ราคา
L -325	325	600	6,400.00
DC-700	500	800	9,600.00

CABLE CUTTER



Cable Preparation Tool Adjustable URD End Stripper
เครื่องลอกฉนวน

Type	Cable Range O.D. inch	Price / ราคา
WS-50	1/2 - 2 1/2	25,000.00
CB-50	Spare Blade	3,600.00



Semi-Con Preparation Tool Adjustable URD Cable Shield
เครื่องลอก Semi-Con

Type	Cable Range O.D. mm	Price / ราคา
EXRM-0946	-40	75,000.00

HAND HYDRAULIC COMPRESSION & CRIMPING TOOLS



Model EP-410

EP-410	
Applicable Range Cu/Al (mm ²)	250
Force at die face (Short ton)	11.4 - 12.5
Ram Stroke (mm)	25
Reservoir Capacity (cc)	124
Withstand Voltage (kV/1min)	20
Weight (kg)	6.2
Price / ราคา	84,000.00



Model EP-431

EP-431	
Applicable Range Cu/Al (mm ²)	250
Force at die face (Short ton)	11.4 - 12.5
Ram Stroke (mm)	31
Reservoir Capacity (cc)	145
Withstand Voltage (kV/1min)	20
Weight (kg)	6.4
Price / ราคา	84,500.00



Model EP-510C

EP-510C	
Applicable Range Cu/Al (mm ²)	380
Force at die face (Short ton)	13
Ram Stroke (mm)	42
Reservoir Capacity (cc)	200
Withstand Voltage (kV/1min)	20
Weight (kg)	7.8
Price / ราคา	91,000.00



UC-6B

UC-6B	
Output force (Metric ton)	5.6
Jaw Opening (mm)	32
Length (mm)	565
Weight (kg)	5
Price / ราคา	78,000.00

HAND HYDRAULIC COMPRESSION, CRIMPING TOOLS & DIES



MODEL : EP-50

Applicable Range		Up to 120mm ² Cu Lug				Price / ราคา
Force at die face		5.2 metric ton				44,500.00
Ram Stroke		10mm to 15 mm adjustable				
Reservoir Capacity		Approx. 60 cc				
Dimensions		130 x372 mm				
Hydraulic oil		SHELL TELLUS T-15 or equal				
Case		Steel carrying case				3,750.00
Dies for Din 46235 Terminals						
Model		K6/8	K10/12	K14/16	K18/20	
Range	Cu	10-16	25-35	50-70	95-120	
	Al	-	16-25	35-50	70-95	

HEXAGONAL DIE FOR EP TYPE		
For copper & Aluminium Terminals Suitable for DIN 46235 Terminals		
Die No.	Cable Size Al/Cu (mm ²)	Price / ราคา
K6	Cu 10	3,500.00
K8	Cu 16	3,500.00
K10	Cu 25 / Al 16	3,500.00
K12	Cu 35 / Al 25	3,500.00
K 14	Cu 50 / Al 30	3,500.00
K16	Cu 70 / Al 50	3,500.00
K18	Cu 95 / Al 70	3,500.00
K20	Cu 120 / Al 95	3,500.00
K22	Cu 150 / Al 120	3,500.00
K25	Cu 185 / Al 150	3,500.00
K28	Cu 240 / Al 185	3,500.00
K32	Cu 300/ Al 240	3,500.00
K34	Cu 400 / Al 300	3,500.00

EP 60 DIES & ADAPTER	
ALCOA TYPE DIES (HEXAGONAL)	
Cable Size Al/Cu (mm ²)	Price / ราคา
Cu 300	12,000.00
Cu 400	12,000.00
Cu 500	12,000.00
Cu 630	12,000.00
Cu 800	12,000.00
Cu 1000	12,000.00
AAC 400	12,000.00
ACSR 477	12,000.00
ACSR 795	12,000.00
ACSR 1272	12,000.00
ADAPTER	12,000.00
EP60 S FOR EP 410 DIES	

Die for H Taps for Tools Model EP

Size (inch)	Price / ราคา
HT41G (UBG)	5,900.00
HT41AK (UO)	5,900.00
HT41V (UD)	5,900.00
HT41X (UD3)	5,900.00
HT41AJ (UN)	5,900.00

Dies for EP-520 & EP-1000

Cable Size Al/Cu (mm ²)	Price / ราคา
240	11,500.00
300	11,500.00
400	11,500.00
500	11,500.00



HAND HYDRAULIC COMPRESSION, CRIMPING TOOLS & DIES



Model: EP-150A

SPECIFICATION		Price ราคา	
Force at die face	90kN		
Applicable range	up to 150sq.mm.		
Die	Nest		Rotary
	Indentor		14, 22, 38-70, 80-150sq.mm.
Size	512 (L) mm		
Weight	7.8 kg (less battery)		
Standard Accessories			
Dedicated Indentor: 14, 22, 38-70, 80-150sq.mm., Carrying case			



No.15B

No.16B

Model	Type	Output (ton)	Weight (kg)	Length (mm)	Applicable Range	Dies	Standard Accessories	Price ราคา
No.15B	Hand hydraulic	6	3	465	T11-T122	T11*,T16*,T20,T26,T44, T60,T76,T98,T122	1. Plastic case 2. Dies-7sets	62,000.00
No.16B	Hydraulic Head	12	4.1	284	T20-T365	T20*,T26*,T44*,T60* T76*,T98*,T122*,T154, T190,T240,T288,T365	1. Plastic case 2. Dies-5sets	92,000.00
Optional dies		For No. 15B					Unit price/Set	5,400.00
Optional dies		For No. 16B					Unit price/Set	9,800.00

(*)Marks show OPTIONAL DIES (Available on request)

HAND HYDRAULIC PUNCH DRIVER & PUNCHER

Model: SH-10(A)P

Model: SH-10(B)P



SH-10(A)P, SH-10(B)P

SH-70B

ACCESSORIES PUNCH SET

HYDRAULIC PIPE BENDER

Model No.	Contents		Price / ราคา
SH-10(A)P	1. HP-180N Hand Pump 2. Setting Thread (3/8&3/4) 3. Collar (Large, Medium, Small)		
SH-10(B)P	4. Puncher Center Gauge 5. Steel Carrying Case		
Standard accessories			
SH-10(A) 5 Punch Set for thin wall	A19 (3/4") A25 (1") A31 (1 1/4")	A39 (1 1/2") A51 (2")	38,000.00
SH-10(B) 6 Punch Set for thick wall	B16 (1/2") B22 (3/4") B28 (1")	B36 (1 1/4") B42 (1 1/2") B54 (2")	42,000.00

Model: SH70B	Specification		Price / ราคา
Output	31 metric tons at 700 kgf/cm ² of oil pressure		95,000.00
Punching	Thickness	13 mm	
Capacity	Hole diameter	o.d. 20.5 mm	
Throat depth	70 mm		
Weight	13 kgs		
Dimensions	360(H)x210(W)x95(D)mm		
Standard Accessories	1. Punch & Die 4 sets 10.5(3/8), 13.5(1/2), 17.5(5/8), 20.5(3/4) 2. Hand pin for easy change of punch & die 3. Steel Carrying Case		
Model	Punch&Die&Size		Price/Sets
70105	10.5 (3/8")		5,000.00
70130	13.5 (1/2")		5,000.00
70175	17.5 (5/8")		5,000.00
70205	20.5 (3/4")		5,000.00

Hydraulic Pipe Bender

Model	Applicable Range		Stoke mm.	Capacity oil	Weight kg.	Price / ราคา
	Thin Steel Conduit (A)	Thick Steel Conduit (B)				
PB10N	15-75 mm. 5/8" - 3"	16-82 mm. 1/2" - 3"	250	400	18.6	49,000.00
PB15N	15-75 mm. 5/8" - 3"	16-82 mm. 1/2" - 4"	250	595	28.8	132,500.00
Standard Accessories						
1. Frame 2. Cylinder 3. Pivot Shoe (2Pcs) 4. Angle Gauge						



DIE & ADAPTER & PUNCHING DIES & BENDING SHOES

Bending Shoe for Benders for Thin Steel Conduit (A)



Pipe Size and Shoe Size	O.D. Pipe (mm)	I.D. Pipe (mm)	Thickness (mm)	Bending Radius	Price ราคา
A15 (5/8")	15.9	13.5	1.2	80	2,250.00
A19 (3/4")	19.1	15.9	1.6	100	2,250.00
A25 (1")	25.4	22.2	1.6	137	2,250.00
A31 (1 1/4")	31.8	28.6	1.6	200	3,050.00
A39 (1 1/2")	38.1	34.9	1.6	220	3,900.00
A51 (2")	50.8	47.6	1.6	365	4,400.00
A63 (2 1/2")	63.5	59.5	2.0	420	4,900.00
A75 (3")	76.2	72.2	2.0	530	4,900.00

Bending Shoe for Benders for Thick Steel Conduit (B)

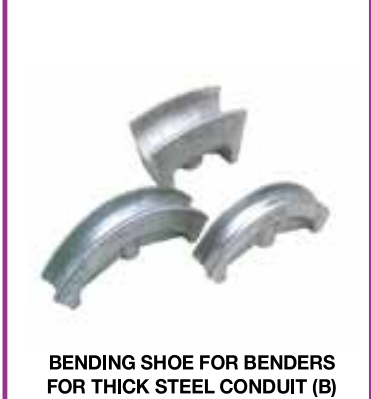

Pipe Size and Shoe Size	O.D. Pipe (mm)	I.D. Pipe (mm)	Thickness (mm)	Bending Radius	Price ราคา
B16 (1/2")	21.0	16.4	2.3	75	2,850.00
B22 (3/4")	26.5	21.9	2.3	90	2,850.00
B28 (1")	33.3	28.3	2.5	130	2,850.00
B36 (1 1/4")	41.9	36.9	2.5	195	4,200.00
B42 (1 1/2")	47.88	42.8	2.5	230	5,950.00
B54 (2")	59.6	54.0	2.8	270	7,600.00
B70 (2 1/2")	75.2	69.6	2.8	450	7,600.00
B82 (3")	87.9	82.3	2.8	500	7,600.00
B92 (3 1/2")	100.7	93.7	3.5	500	16,700.00
B104 (4")	113.4	106.4	3.5	680	16,700.00

Punching Dies for Thin Wall Conduit



Conduit Size and Punch Set	I.D. Pipe (mm)	Punching Diameter (mm)	Price ราคา
A16 (5/8")	15.9	16.5	1,350.00
A19 (3/4")	19.1	19.1	1,350.00
A25 (1")	25.4	26.1	1,500.00
A31 (1 1/4")	31.8	32.5	1,850.00
A39 (1 1/2")	38.1	38.7	2,300.00
A51 (2")	50.8	51.6	3,100.00
A63 (2 1/2")	63.5	64.4	4,550.00
A75 (3")	76.2	77.2	5,900.00

Punching Dies for Thick Wall Conduit

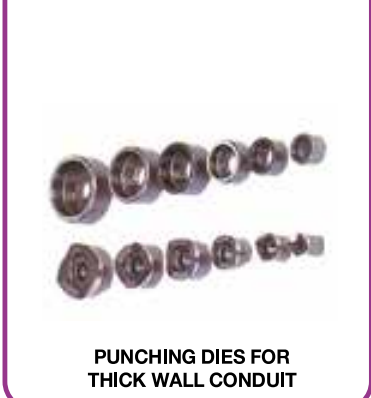

Conduit Size and Punch Set	O.D. Pipe (mm)	Punching Diameter (mm)	Price ราคา
B16 (1/2")	21.0	21.8	1,350.00
B22 (3/4")	26.5	27.6	1,350.00
B28 (1")	33.3	34.1	1,500.00
B36 (1 1/4")	41.9	42.7	1,850.00
B42 (1 1/2")	47.8	48.7	2,300.00
B54 (2")	59.6	60.5	3,100.00
B70 (2 1/2")	75.2	76.1	4,550.00
B82 (3")	87.9	88.9	5,900.00
B92 (3 1/2")	100.7	102.8	10,550.00
B104 (4")	113.4	115.5	12,400.00



HAND HYDRAULIC CUTTER TOOLS



SELECTION CHART (Maximum Cutting Capacity)

Model	Output (ton)	Max Handle Load (kgf)	Weight (kg.)	Length (mm.)	Wire Rope			Round Bar				Wire stand			Cable			Price	
					6x7 Hemp-Core	6x12 Hemp-Core	6x19 Hemp-Core	Soft Cu bar	Soft Al bar	Soft Steel bar	Reinforcing bar	Str. Cu bare	Str. Al bare	ACSR	Guy wire steel stand	Tele phone cable CCP	Lead Sheathed telephone Cable		Under ground Cable
S200	4	18	2.8	390	16	20	20	20	16	16	13	20	20	21	16	-	-	18	47,000.00
S240	7.8	28	4	426	18	24	24	24	18	20	16	24	24	24	20	-	-	24	69,000.00
S320	20	29	9.3	675	32	32	32	32	32	25	25	32	32	32	-	-	32	84,000.00	
S400	6	20	5.7	580	22	25	25	21	20	20	16	41	41	38	20	-	-	41	69,000.00
S550G	12	30	10	625	25	30	30	-	-	22	19	54	54	54	20	-	-	-	92,000.00
850	3	16.5	8.2	710	-	-	-	-	-	-	-	28	38	-	-	85	85	50	78,500.00

CAUTION :

1. Cutting of P.C. wire or Piano Wire is prohibited.
2. Stay within the Maximum Cutting Capacity of each tool.
3. Do not pump with more than Maximum Handle Load of each tool.



HYDRAULIC CUTTER HEADS

Hydraulic Cutter Heads (Scissors Type & Chain Cutter)

Model	Output Metric (ton)	Cutting Capacity		Lenght (mm)	Weight (kg)	Price บาท
		Al	Cu			
YSP-30B	6.7	28mm	28mm	295	2.9	53,000.00
		ACSR				
		19mm				

SELECTION CHART (Maximum Cutting Capacity)

Model	Output (ton)	Weight (kg.)	Length (mm.)	Wire Rope			Round Bar				Wire stand			Cable			Price บาท	
				6x7 Hemp-core	6x12 Hemp-Core	6x19 Hemp-Core	Soft Cu bar	Soft Al bar	Soft Steel bar	Reinforcing bar	Str. Cu bare	Str. Al bare	ACSR	Guy wire steel stand	Tele phone cable CCP	Lead Sheathed telephone Cable		Under ground Cable
SP-20A	4	2.3	234	16	20	20	20	16	16	13	20	20	21	16	-	-	18	33,000.00
SP-24	7.8	3.1	245	18	24	24	24	18	20	16	24	24	24	20	-	-	24	50,000.00
SP-32	20	10	298	32	32	32	32	32	25	25	32	32	32	-	-	32	78,000.00	
SP-40A	6	4	340	22	25	25	22	20	20	16	41	41	38	20	-	-	41	53,000.00
SP-55A	12	9.5	415	25	30	30	35	28	22	19	50	50	50	20	-	-	50	78,000.00
P-85	3	7.2	456	-	-	-	-	-	-	-	28	46	-	-	85	85	50	59,800.00
P-100A	7.5	13.5	570	-	-	-	-	-	-	-	42	46	-	-	100	100	75	88,500.00

CAUTION :

1. Cutting of P.C. wire or Piano Wire is prohibited.
2. Stay within the Maximum Cutting Capacity of each tool.
3. Do not pump with more than Maximum Handle Load of each tool.



HYDRAULIC COMPRESSION & CRIMPING HEADS



Model 12A

EP-510HC

EP-431H

EP-410H

EP-520C

Model 12A

Weight (kg.)	Applicable Range			Dies		Output (ton)	Standard Accessories	Price ราคา
	JIS	AWG	DIN	Nest	Indentor			
7.5	8	8	10	8*	8-14*	12 Oil Volume 100 cc.	1. Indentor 3 Pcs 2 Nest (Female) 7 Pcs 3 Steel case (*) Marks show option Dies Available on request	79,500.00
	14	6	16	14*				
	22	4	25	22*	22-60			
	38	2	35	38*				
	60	1/0	50	60*	70-100			
	70	2/0	70	70*				
	80	3/0	95	80	150-325			
	100	4/0	120	100				
	150	300	150	150				
	180	350	185	180				
200	400	240	200					
325	600	300	325					

Model EP-410H, EP-431H, EP-510HC

Model	Applicable Range Cu/Al/mm ²	Force at die face (Short ton)	Ram Stroke (mm.)	Oil Volume Required (cc.)	Weight (kg.)	Price ราคา
EP-510HC	380	13	38	75	5.1	59,000.00
EP-431H	250	11.4-12.5	30	50	4.5	50,000.00
EP-410H	250	11.4-12.5	25	42	3.6	49,000.00

Model EP-520C

	Applicable Range (mm ²)			Price ราคา
	JIS	AWG	DIN	
Al	520	1000	500	93,000.00
Cu	520	1000	500	
ACSR	520	1000	500	
Force at die face 30 short ton				
Ram stroke 26 mm.				
Dimension 120(Dia)x370(H)				
Weight 16 kg.				

**HYDRAULIC COMPRESSION HEAD SINGLE ACTING
& DOUBLE ACTING FOR TRANSMISSION LINE**



EP-60S



EP-100W



EP-200W

Specification

Model	Force at die face (Short ton)	Ram Stroke (mm)	Oil volume required (cc)	Dimension (with ground stand) mm	Weight (kg)	Price រៀល
EP-60S	60	38.5	303	146x446	22	185,000.00
EP-100W	100	22	314	195x359	32	186,000.00
EP-200W	200	40	1134	370x445	86	575,000.00

*HPE-4 hydraulic pump is recommended to operated above heads.

*Dies are manufactured on request only. Detailed information is required.



Model EP-610HS2

Model	Output	Jaw opening	Length	Weight	Accessories	Price / រៀល
EP-610HS2	15 short ton 14.2 metric ton	50 mm. (45mm. with die adapter)	375 mm.	6.8 kg.	Steel carrying case with die tray	97,000.00
Model	PU ADAPTER & DIES					Price / រៀល
610100	PU ADAPTER					19,600.00
610300	EP-610HS2 DIES For Cu or Al 300mm ²					9,200.00
610400	EP-610HS2 DIES For Cu or Al 400mm ²					9,200.00
610500	EP-610HS2 DIES For Cu or Al 500mm ²					9,200.00



HYDRAULIC PUMPS SINGLE & DOUBLE ACTING



Model	Pump Speed	Pressure Rating kgf/cm ²	Oil Delivery cc/stroke	Reservoir Capacity cc	Dimension LxWxH(mm)	Weight kg	Price ราคา
HP-700A	2 Speed	Low 0-20 High 20-700	12.26 2.26	720	580x140x160	10.5	36,700.00
FP-700A	2 Speed	Low 0-20 High 20-700	12.26 2.26	720	720x150x190	12	42,000.00

Remarks:
 HP-700A with 2m hydraulic hose.
 FP-700A hose sold separately.



HYDRAULIC HOSE AND BI COUPLER

Wire Wound HOSE



Model	Length M	Price ราคา
00500 WH	0,5	4,050.00
01000 WH	1	6,100.00
02000 WH	2	10,000.00
03000 WH	3	11,500.00
04000 WH	4	15,200.00
05000 WH	5	18,200.00
06000 WH	6	19,900.00
08000 WH	8	24,200.00
10000 WH	10	31,700.00
12000 WH	12	35,600.00
15000 WH	15	42,000.00

Non-Conductive HOSE

Model	Length M	Price ราคา
01000 NH	1	8,400.00
02000 NH	2	10,700.00
03000 NH	3	14,400.00
04000 NH	4	17,000.00
06000 NH	6	22,000.00
10000 NH	10	34,000.00
12000 NH	12	38,600.00
15000 NH	15	44,600.00

BI Type Coupler

100038 M	Male	2,800.00
100039 F	Female	4,250.00

HYDRAULIC PUMPS SINGLE & DOUBLE ACTING

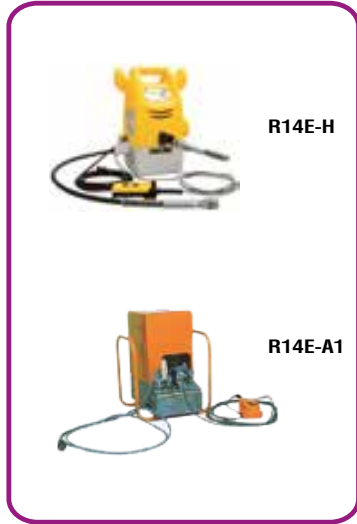

Motor Driven Hydraulic Pumps Single&Double Acting

Model	Valve Type	Pump Speed	Pressure Rating kgf/cm ²	Oil Delivery (l/min)	Reservoir Capacity cc	Dimension LxWxH(mm)	Weight kg	Price บาท
R14E-H	Electric	2 Speed	Low 0-20 High 20-700	2.9 0.3	1700	306x205x393	16	134,000.00
R14E-A1	Electric	2 Speed	Low 0-20 High 20-700	2.6 0.6	3000	354x200x403	30	243,000.00



Engine Driven Hydraulic Pump

Detail	Model			
	HPE-100S	HPE-100D	HPE-160	HPE-160M
Type	single acting	Double Acting	Double Acting	Double Acting
Rate pressure	68.5 Mpa or 10,000 psi			
Oil delivery				
Low pressure	2.6 liter/min	2.6 liter/min	7.5 liter/min	7.5 liter/min
High pressure	0.5 liter/min	0.5 liter/min	1.2 liter/min	1.2 liter/min
Reservoir Capacity	10 liter			
Engine	Honda			
Model	GX-100	GX-100	GX-160	GX-160
Type	Air cooled 4 cycle gassoline engine			
Fuel	Lead free gassoline			
Control method				
Manual	-	Yes	Yes	Yes
Remote Control	Yes	Yes	Yes	Yes
Size (LxHxW) mm	530x350x490	590x350x445	665x405x445	675x405x475
Weight (kg)	34.5	38.5	61	61
Price (บาท)	330,000.00	450,000.00	525,000.00	450,000.00

SERIES7[®]

7th GENERATION BATTERY OPERATED TOOL PORTABLE HAND-HELD, FULLY AUTOMATIC COMPRESSION TOOLS

SPECIFICATIONS											
	S7G-510H	S7G-510R	S7G-510M	S7G-431H	S7G-431R	S7G-431M	S7G-630H	S7G-630R	S7G-630M		
Output Force	120 kN						60 kN				
Jaw Opening/Ram stroke	42 mm			31 mm			32 mm				
Compression range	16 - 400 mm ²						16 - 300 mm ² (Anderson type)				
Compression speed *depends on size of lug	approx. 6-10 sec.		approx. 8-12 sec.		approx. 6-10 sec.		approx. 8-12 sec.		approx. 6-10 sec.	approx. 8-12 sec.	
Compression Cycle *at 150 mm ² Copper lug	approx. 110 times										
Auto retract function	Yes										
Record operation log (pressure sensor + GPS + Bluetooth)	Yes	No		Yes	No		Yes	No			
Maintenance notification	Yes	No		Yes	No		Yes	No			
Battery indicator	Yes										
Battery	IZUMI BP-2140		Makita BL1830B		IZUMI BP-2140		Makita BL1830B		IZUMI BP-2140		Makita BL1830B
Battery Voltage	21.6V		18V		21.6V		18V		21.6V		18V
Battery Capacity	4.0Ah, Li-ion		3.0Ah, Li-ion		4.0Ah, Li-ion		3.0Ah, Li-ion		4.0Ah, Li-ion		3.0Ah, Li-ion
Charger	CH-21E		DC18RC		CH-21E		DC18RC		CH-21E		DC18RC
Charging time	75 min.		22 min.		75 min.		22 min.		75 min.		22 min.
Size	436 x 297 x 92 (mm)		436 x 286 x 92 (mm)		413 x 301 x 92 (mm)		413 x 289 x 92 (mm)		401 x 309 x 82 (mm)		
Weight (with battery)	7.9 kg		7.6 kg		7.9 kg		7.6 kg		5.8 kg		5.6 kg
PRICE*	โปรดสอบถาม	โปรดสอบถาม	โปรดสอบถาม	โปรดสอบถาม	โปรดสอบถาม	โปรดสอบถาม	โปรดสอบถาม	โปรดสอบถาม	โปรดสอบถาม	โปรดสอบถาม	

* ราคาไม่รวม Battery, Charger และ Die

SERIES7[®] PORTABLE HAND-HELD, CUTTING TOOLS

SPECIFICATIONS							
	S7G-S40R	S7G-S40M	S7G-K105R	S7G-K105Y	S7-K50-GE	S7-K50M	
Output Force	70 kN			124 kN		-	
Opening / Stroke	40 mm			105 mm		-	
Cutting capacity	Max. 40mm	Max. 40mm	Max. 105 mm dia.	Max. 105 mm dia.	Max. 50 mm	Max. 50 mm dia.	
Cutting cycle	approx. 45 times (at Φ38mm ACSR)			-	-	-	
Battery	IZUMI BP-2140		Makita BL1830B		IZUMI BP-2140		Makita BL1830B
Battery Voltage	21.6V		18V		21.6V		18V
Battery Capacity	4.0Ah, Li-ion		3.0Ah, Li-ion		4.0Ah, Li-ion		3.0Ah, Li-ion
Charger	CH-21E		DC18RC		CH-21E		DC18RC
Charging time	75 min.		22 min.		75 min.		22 min.
Size	445 x 09 x 92 (mm)			601 x 358 x 92 (mm)		330 x 152 x 117 (mm)	
Weight with battery	7.0kg	6.9kg	9.1 kg	9.0kg	2.9 kg	2.8 kg	
PRICE*	โปรดสอบถาม	โปรดสอบถาม	โปรดสอบถาม	โปรดสอบถาม	โปรดสอบถาม	โปรดสอบถาม	

* ราคาไม่รวม Battery และ Charger

BATTERY OPERATED HYDRAULIC TOOLS
PORTABLE HAND-HELD, FULLY AUTOMATIC COMPRESSION TOOLS

Model	REC-6431	
Application Range	Accept existing 12 ton U-type dies	 REC-6431
Force at die face	120 kN	
Ram Stroke	31 mm	
Motor	14.4 V DC	
Size	284 (L) x 431 (H) x 84 (W) mm	
Weight	6.45 kg (Less battery)	
Battery Type	Ni-Cd	
Price / ราคา	195,000.00	
Standard Accessories: Battery and Charger, Shoulder Strap & Carrying Case		

Model	REC-6630	
Application Range	50-185 mm ² (32 mm)	 REC-6630
Force at die face	60 kN	
Ram Stroke	31.5 mm	
Motor	14.4 V DC	
Size	409 (L) x 270 (H) x 79 (W) mm	
Weight	4.6 kg (Less battery)	
Battery Type	Ni-Cd	
Price / ราคา	200,000.00	
Standard Accessories: Battery and Charger, Shoulder Strap & Carrying Case		

Model	REC-6200MX	
Application Range	A multipurpose tool operated for various type of crimping, cutting, punching and etc.	
Output	127 kN	 REC-6200MX
Ram Stroke	22 mm	
Motor	14.4 V DC	
Size	383 (L) x 261(H) x 79 (W) mm	
Weight	5.0 kg (Less battery)	
Battery Type	Ni-Cd	
Price / ราคา	210,000.00	
Standard Accessories: Battery and Charger, Shoulder Strap, Carrying Case and Indenting dies Nest: Nest wheel & 200dies Indenter: 14, 22, 38-70, 80-150, 200		

- Optional Attachments
- Cable cutter : up to 50 mm dia (non ferrous cable only)
 - Re-bar cutter : 16 mm rebar, 16 mm soft steel bar
13 mm stainless steel bar
 - Thread bar cutter : W3/8" Soft steel
W1/2" Soft steel (die sold separated)
 - Knock out puncher : up to 115.50 mm dia hole, 3.2 mm thick mild steel
(Punch and die sold separated)
 - Angle steel puncher : 10.5, 13.5, 17.5 mm dia., 6 mm thick steel
 - Raceway cutter : D-1, S-D1, P-1, D-2 type
 - Compression : Hex die Copper 8-200 mm²



BATTERY OPERATED HYDRAULIC TOOLS PORTABLE HAND-HELD, FULLY AUTOMATIC COMPRESSION TOOLS

MODEL	REC-S624	
Output force	84 kN	 REC-S624
Ram Stroke	26 mm	
Motor	14.4 V DC	
Size	350 (L) x 260 (H) x 79 (W) mm	
Weight	4.3 kg (Less battery)	
Battery Type	Ni-Cd	
Price / ราคา	170,000.00	
Standard Accessories: Battery and Charger, Shoulder Strap & Carrying Case		

Cutting Capacity & Estimated Cutting cycles		
Material	Capacity OD	Cutting Cycle
Wire rope 6 x 7	18 mm	82
Wire rope 6 x 12	24 mm	105
Wire rope 6 x 19	24 mm	67
Soft steel bar	20 mm	90
Re-bar	16 mm	120
Cu strands	24 mm	120
Al strands	24 mm	150
ACSR	24 mm	142
Guy wire 1 x 7	20 mm	127
Guy wire 1 x 19	20 mm	120

Model	REC-630Y	
Output force	60 kN	
Ram Stroke	21 mm	
Motor	14.4 V DC	
Weight	3.5 kg (Less battery)	
Size	403 (L) x 291 (H) x 80 (W) mm	
Standard Accessories	Battery and Charger, Shoulder Strap & Carrying Case	
Price / ราคา	120,000.00	

**BATTERY OPERATED HYDRAULIC TOOLS
PORTABLE HAND-HELD, FULLY AUTOMATIC COMPRESSION TOOLS**

MODEL	REC-S640	
Output force	70 kN	 <p>REC-S640</p>
Ram Stroke	44 mm	
Motor	14.4 V DC	
Size	460 (L) x 272 (H) x 80 (W) mm	
Weight	6.0 kg (Less battery)	
Battery Type	Ni-Cd	
Price / ราคา	245,000.00	
Standard Accessories: Battery and Charger, Shoulder Strap & Carrying Case		

Cutting Capacity & Estimated Cutting cycles		
Material	Capacity OD	Cutting Cycle
Wire rope 6 x 7	22 mm	60
Wire rope 6 x 12	22 mm	82
Wire rope 6 x 19	22 mm	45
Soft steel bar	20 mm	60
Re-bar	16 mm	60
Cu strands	40 mm	42
Al strands	40 mm	52
ACSR	38 mm	45
Guy wire 1 x 7	15 mm	120
Guy wire 1 x 19	20 mm	72



BATTERY OPERATED HYDRAULIC TOOLS PORTABLE HAND-HELD, FULLY AUTOMATIC COMPRESSION TOOLS

MODEL	REC-105YC	
Output force	80 kN	 REC-105YC
Ram Stroke	105 mm	
Motor	14.4 V DC	
Size	615 (L) x 335 (H) x 100 (W) mm	
Weight	8.2 kg (Less battery)	
Battery Type	Ni-Cd	
Price / ราคา	295,000.00	
Standard Accessories: Battery and Charger, Shoulder Strap & Carrying Case		

Cutting Capacity & Estimated Cutting cycles		
Material	Capacity OD	Cutting cycle
Polyethylene cable		
600V-CV325mm²	60 mm (3 core)	22
600V-CV150mm²	46 mm (3 core)	60
600V-CV500mm²	38 mm (3 core)	45
Multi-core vinyl insulation cable		
VVR 150mm²	47 mm (3 core)	60
CCP cable	85 mm	45
Lead sheathed cable	85 mm	45

**BATTERY OPERATED HYDRAULIC TOOLS
PORTABLE HAND-HELD, FULLY AUTOMATIC COMPRESSION TOOLS**



REC-54M

REC-50M

MODEL	REC-54M	REC-50M
Max cutting OD.	54 mm	50 mm
Cutting Capacity	AL : 750 mm ² / CU : 375 mm ² ACSR: 560 mm ²	AL : 750 mm ² / CU : 500 mm ²
Motor	14.4 VDC	
Size	110 (L) x 365 (H) x 109 (W) mm	110 (L) x 365 (H) x 109 (W) mm
Weight	2.6 kg (Less battery)	2.6 kg (Less battery)
Battery Type	Ni-Cd : BP-70E, BP-70EI, BP-70MH Li-Ion : BP-80LI	Ni-Cd : BP-70MH
Price / ราคา	71,000.00	60,000.00
Standard Accessories: Battery and Charger & Carrying Case		



REC-54ACM

MODEL	REC-54ACM
Max Cutting OD.	54 mm
Cutting Capacity	AL : 750 mm ² / CU : 375 mm ² / ACSR : 560 mm ²
Motor	14.4 V DC
Weight	2.6 kg (Less battery)
Battery Type	Ni-Cd : BP-70E, BP-70EI, BP-70MH
Size	110 (L) x 365 (H) x 109 (W) mm
Price / ราคา	120,000.00
Standard Accessories: Battery and Charger & Steel Carrying Case	



BATTERY OPERATED HYDRAULIC TOOLS PORTABLE HAND-HELD, FULLY AUTOMATIC COMPRESSION TOOLS

MODEL	REC-55PDF		
Application Range	Punching capacity 3.2mm thick mild steel or 1.6mm stainless steel with 104mm (4") holes		
Output force	73 kN		
Ram Stroke	22 mm		
Motor	14.4 V DC		
Weight	3.8 kg (Less battery)		
Size	328 (L) x 254 (H) x 70 (W) mm		
Standard Accessories	Battery and Charger, Shoulder strap, Carrying case, Center gauge, Setting threads (3/4 & 3/8) and Collar (L, M, S, SS)		
Price / ราคา	โปรดสอบถาม		

BATTERY & CHARGER



BP-70MH

BP-80LI

BP-14LN

Battery Cartridge

Detail	Model		
	BP-70MH	BP-80LI	BP-14LN
Type	Nickel Cadmium (Ni-Cd)	Lithium Ion (Li-ion)	
Voltage (VDC)	14.4		
Capacity (Ah)	3	3	3
Charging time	40	40	40
Size (LxHxW) mm	100x140x70	100x137x75	107x140x70
Weight (kg)	0.85	0.58	0.57
LED Indicator	No	Yes	No
Price / ราคา	18,000.00	18,000.00	18,000.00
For used with charger	Model CH-35EMCv		Model CH-25LNW

BATTERY & CHARGER



Battery Charger

Detail	Model	
	CH-100	CH-25LNW
Input Voltage	100-240 VAC or 12/24 VDC	100-240 VAC
Capacity (VA)	-	145-148
Charging time		
BP-14LN	-	40 mins
BP-70E	80 mins	-
BP-70EI	80 mins	-
BP-70MH	100 mins	-
BP-80LI	90 mins	-
Size (LxHxW) mm	130x94x79.5	230x80x145
Weight (kg)	0.68	1.60
Other feature	Can be plugged directly into an automotive cigarette lighter socket	-
Price / ราคา	18,000.00	22,000.00

GROUP F

MEASURING & INSTRUMENT



METER

Meter Cabinet, Seal and Meter Board



Watt-Hour Meter

Type	Rating	Price ₹
Single Phase 2 wires, 220V	5/15 A	1,200.00
	15/45 A	1,500.00
	30/100 A	2,000.00
Three Phase 4 wires, 220/380V	15/45 A	5,000.00
	30/100 A	5,000.00



**GE 3P4W
DEMAND, TOU**

**Programmable Watthour Demand Meter & TOU Meter
3 phase 4-wires, 220/380 V use with CT. 5 A**

Type	Rating	Price ₹
kv2C	2.5 (10) A	40,000.00



**GE 3P3W
DEMAND, TOU**

**Programmable Watthour Demand Meter & TOU Meter
3 phase 3-wires, 110V use with CT. and PT.**

Type	Rating	Price ₹
kv2C-DEMAND	2.5 (10) A	40,000.00
kv2C-TOU	2.5 (10) A	50,000.00



GK Meter Cabinet

Meter Cabinet

Outdoor Type size mm.	Price ₹
AL. 600x250x270 for 3P and TOU meter	2,000.00
AL. 800x250x270 for DEMAND meter	2,000.00
Steel 800x250x295 for CT operated meter	2,500.00



Security seal



Padlock seal

Meter Seal

Type	Price ₹
Plastic security seal	5.00
Galvanized padlock seal	10.00

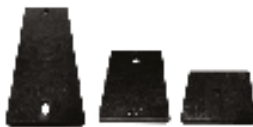

Meter Board

Meter Board

size mm.	Price ₹
20x20x2	60.00
20x60x2	120.00
20x120x2	240.00

VOLTSTIK RADIO BASED DISTRIBUTION VOLTMETERS

เครื่องวัดแรงดันไฟฟ้าแบบไร้สาย

Safely and accurately measure the primary voltage

Non-conductive meter case and universal adaptor

Remote display for instant confirmation of the reading

Take Phase to Phase and Phase to Ground measurements

Single stick operation

Holds up to four unique readings



Specification	Model 6-133 Voltstik Kit Consists of 8-133 Voltstik and 8-121 Radio Receiver
Voltage range	0 - 37 kV
Resolution Voltage 0-37 kVAC	1 V
Accuracy	$\pm 1\%$ ± 2 V
Operation	
Frequency	50 Hz (47 to 53 Hz)
Control	One button operation
Storage	4 readings
Mechanical	
Display	5 digit
Housing	Shock & water resistant mold urethane
Hot stick mounting	Universal shuck adapter (Hotstick not include)
Battery	9 V alkaline
Operation Temp.	-30 to 60 C degree
Weight	
8-133 Voltstik	2.62 kg
8-121 Receiver	0.64 kg
Radio	
Frequency	916.48 MHz (region 2 & 3)
Frequency	869 MHz (region 1)
Power	1 mW
Range	50 ft (15.24 m)
Price	250,000.00



RADIO AMPSTIK RADIO LINKED MULTIPLE READING AMMETER



เครื่องวัดกระแสไฟฟ้าแบบไร้สาย

- Heads Up Display for instant conformation of the reading
- Records up to four readings
- Operates in the 900 MHz non licensed frequency band
- Mount the Display on the hotstick or hold in your hand
- Remote read out up to 50 feet away
- New Non Conductive Universal Chuck

Specification	Model 6-120 Kit
Voltage range	0 - 69 kV
Current range	1 - 5000 A
Sensor Opening	Standard
Opening width	2.5"
Resolution	
Amps 1-99.9 A	0.1 A
Amps 100-5000 A	1 A
Accuracy	$\pm 1\%$ ± 2 V
Operation	
Frequency	50 Hz (47 to 53 Hz)
Control	One button operation
Storage reading	4 reading
Mechanical	
Display	5 digit
Housing	Shock & water resistant mold urethane
Hot stick mounting	Universal shuck adapter (Hotstick not include)
Battery	9 V alkaline
Operation Temp.	-30 to 60 C degree
Weight	1.05 kg
Radio	
Frequency	916.48 MHz
Power	1 mW
Range 50 ft	(15.24 m)
Price	250,000.00





QUALISTIK PLUS POWER QUALITY METER (POWER FACTOR METER)

เครื่องวัดคุณภาพไฟฟ้า

Slip over a high voltage conductor and collect four power quality measurements

- Measure Amps
- Measures leading or lagging Power Factor
- Measures Total Harmonic Distortion (THD)
- Indicates Direction of Current Flow
- Store up to eight sets of readings



Specification	Model	
	8-061XT Plus	8-062 Plus
Measurement		
Voltage range	500 kV	
True RMS Amp	1 - 2000 A	5 - 2000 A
Power factor	0.01 - (lag) to 0.01 + (lead)	
THD Amps	1 - 100%	
Resolution		
Amp 1-99 A	0.1 A	
Amp 100-2000 A	1 A	
Power factor	1.0 to 0.01	
THD Amps	1 %	
Accuracy		
Amps	+1% + 2 counts	
Power factor	+0.1 from 0.71 lead to 0.71 lag	
THD Amps	+1% from 0 to 25%	
(Note: Accuracy is diminished if the current is less than 15A)		
Operation		
Frequency	50 Hz (47 to 53 Hz)	
Control	One button operation	
Storage reading	8 reading	
Mechanical		
Sensor opening	Standard	Wide Jaw
Opening width	2.5"	3.86"
Display	Graphic LCD	
Housing	Shock & water resistant mold urethane	
Hot stick mounting	Universal shuck adapter (Hotstick not include)	
Battery	9 V alkaline	
Operation Temp.	-30 to 60 C degree	
Weight	1.05 kg	1.41 kg
Option		
Hand carrying case	model 7 - 044	
Price	275,000.00	310,000.00



SENSORLINK AMPSTIK HIGH VOLTAGE AMMETER

เครื่องวัดกระแสไฟฟ้า

- Slips on and off the conductor with $\pm 1\%$ accuracy
- Measures Amps averaging true RMS
- Open CT that rejects stray magnetic fields
- Sample and hold measurements
- High voltage rated 500kV



Specification	Model						
	8-020XT	8-022	8-023	8-024	8-020XT Plus	8-022 Plus	8-024 Plus
Voltage range	0 - 500 kV	0 - 69 kV	0 - 69 kV	0 - 400 kV	0 - 500 kV	0 - 69 kV	0 - 400 kV
Current range	0 - 5000 A	0 - 2000 A	0 - 5000 A	0 - 2000 A	0 - 5000 A	0 - 2000 A	0 - 2000 A
Sensor Opening	Standard	Wide Jaw			Standard	Wide Jaw	
Opening width	2.5"	3.86"			2.5"	3.86"	
Resolution							
Amps 0-99 A	0.1 A	-	-	-	0.1 A	-	-
Amps 0-199 A	-	1 A	1 A	1 A	-	1 A	1 A
Amps 200-1999 A	1 A	1 A	1 A	1 A	1 A	1 A	1 A
Amps 2000-5000 A	0.01 kA	-	0.01 kA	-	0.01 kA	-	-
Accuracy	+1% +2 counts						
Operation							
Frequency	50 Hz (47 to 53 Hz)						
Control	One button operation						
Storage reading	-				4 current readings		
Mechanical							
Display	3.5 digit						
Housing	Shock & water resistant mold urethane						
Hot stick mounting	Universal shuck adapter (Hotstick not include)						
Battery	9 V alkaline						
Operation Temp.	-30 to 60 C degree						
Weight	1.14 kg						
Accessorie	Soft carrying case						
Option							
Hard carrying case	model 7-044						
Price	136,000.00	165,000.00	186,000.00	186,000.00	150,000.00	179,000.00	200,000.00

F

OHMSTIK PLUS LIVE-LINE OHMMETER



- Measure microhm resistance on a live high voltage conductor
- Superior measurement compared to infrared thermography
- Measure exact resistance or compare to a nearby conductor
- Measures up to Nine sets of readings
- Measures resistance using AC current in the line
- Measures and displays both amps and micro-ohms
- Simple to use one button operation

Specification	Model	
	8-082XT Plus	8-084 Plus
Measurement		
Voltage range	500 kV	
Amps	1 - 1400 A	
Micro-Ohm	5 - 2500 $\mu\Omega$	
Resolution		
Amps 1-99 A	0.1 A	
Amps 100-1400 A	1 A	
Micro-Ohm 1-999	1	
Micro-Ohm 1000-2500	1.0	
Accuracy		
Amps	+1% +1 A	
Micro-Ohm absolute	+2% +2 $\mu\Omega$	
Micro-Ohm repeatability	+1% +2 $\mu\Omega$	
(Note: Accuracy is diminished if the current is less than 15 A while on 0-35 kV and when current is less than 50 A while on 36-500 kV)		
Operation		
Frequency	50 Hz (47 to 53 Hz)	
Control	One button operation	
Storage reading	9 readings	
Mechanical		
Sensor Opening	Standard	Wide Jaw
Opening width	2.5"	3.86"
Display	Graphic LCD	
Housing	Shock & water resistant mold urethane	
Hot stick mounting	Universal shuck adapter (Hotstick not include)	
Battery	9 V alkaline	
Operation Temp.	-30 to 60 C degree	
Weight	1.05 kg	1.41 kg
Option		
Hard carrying case	model 7-044	
Price	412,000.00	430,000.00



HD ELECTRIC COMPANY



INSULATOR TESTER

The Hi-Test Insulator Tester tests energized or de-energized suspension insulators for non-visible internal failures at any AC line voltage. These non-visible failures are known as Causes (OCR) operations and blown fuses. They are also a threat to line crew safety when performing energized maintenance.

FEATURES

- Universal spline for attachment to a hotstick.
- Built-in gigohmmeter applies a current limited 10k VDC potential across an insulator.
- Buzzer provides audible warning of bad insulator.
- LED meter display the condition of the insulator being tested.
- Powered by an 8 VDC rechargeable battery, lasts for several days of testing.
- Carrying case included.
- Weight – approximately 3 lbs. (1.36 kg).

Price : 560,000 ₪



SURGE ARRESTER TESTER

The Hi – Test line of Surge Arrester Testers perform nondestructive testing of surge arresters for non – visible internal breakdown. These breakdowns are a known cause of blinking lights and RF/TVI. Arresters rated for 3kV to 18kV can be tested with this line of equipment.

FEATURES

- Voltage range 0-21 kVDC for use on arrester classes up to 15 kVAC
0-30 kVDC for use on arrester classes up to 25 kVAC
- Voltage output is easily controlled and clearly displayed in 700 or 1000 volt steps (depending on model) on an LED meter
- Leakage current is displayed on a 50 microamp LED meter scale in microamp steps.
- Powered by a 12 VDC rechargeable gel cell battery.
- Equipped with pivoting handle and belt clip for portability and hand free use; weight approximately 3 lbs. (1.36 kg.)
- Includes mountable wall storage rack

Price : 470,000 ₪

ROPE TESTER

The Hi- Test Rope Tester is designed to test hot line ropes, slings and straps for dielectric integrity at the time and location they are being used. Ropes with diameters ranging from 3/8" in diameter (9.5mm) to 1 1/2" in diameter (38mm) can be tested along with slings and straps of various size.

FEATURES

- Continuously test any length of rope or straps.
- Dielectric condition is displayed by Green (good) or Red (bad) LED.
- Powered by a 8VDC rechargeable battery.
- Audible buzzer sounds if defective rope is found.
- Small, portable and easy-to-use.

Price : 330,000 ₪





HD ELECTRIC COMPANY



Digital Voltage Indicators

The DVI Series Digital Voltage Indicators (DVI) are single point instruments designed to read the voltage on a conductor up to 0-500kV line-to-ground. The large LED readout is easy-to-read on the end of a long hotstick and can be used on overhead lines or in underground applications with an underground bushing probe. There are two versions of the DVI series. The DVI series indicates voltage by directly contacting conductors on transmission and distribution systems in both overhead and underground applications. The DVI series with Test Point Mode also indicates voltage on elbow test points.

Digital Voltage Indicator Features

Model DVI-100 : For use on system voltages up to 161kV (99kV line-to-ground maximum)

Model DVI-500 : For use on system voltages up to 800kV (500kV line-to-ground maximum)

- * Large auto-ranging LED display indicates the line-to-ground voltage level
- * Audible indication of voltage detected
- * Voltage readout allows user to distinguish between nominal and induced voltage levels
- * Use on overhead or underground applications (underground probe required)
- * Built-in universal splice for standard hotstick attachment
- * Powered by a field replaceable 9-volt alkaline battery
- * Auto shut-off
- * Voltage Detector Tester, available as a power source to test the DVI before and after use
 - o PT-DET (optional) for DVI-100
 - o PT-DVI (optional) for DVI-500

Price : Model DVI - 100 : 120,000 บาท (ไม่รวม Hot stick)

Model DVI - 500 : 170,000 บาท (ไม่รวม Hot stick)



HD ELECTRIC COMPANY

V-Watch Personal Voltage Detectors

Worn on the outside of your clothing at mid-torso, the V-Watch provides that extra level of safety by detecting and alerting you to the presence of electrical fields or energized electrical equipment. In emergencies, you and your crews can move in safely to quickly restore power to your customers. The V-Watch is available in both a standard model and a pro model with a mute feature. Each comes in a tough nylon carrying case lanyard that is worn around the neck during use.



Features and Benefits

- Alerts user to proximity of high voltage
- Audible and visual alarms increase in frequency the closer the user gets to energized equipment
- Typical V-Watch warning distance is about 7 feet (2.13 m) from a 4kV AC conductor (see instruction manual for more details)• Provides another level of safety for storm restoration workers and first responders
- Low battery indicator• Field replaceable 9V battery
- Rugged protective housing
- Built-in self test
- Lightweight
- Carrying case lanyard
 - Electrically shielded
 - Storage case when the V-Watch is not in use
 - Lanyard allows user to adjust to optimum mid-torso position

Specifications

- Sensitivity: Factory set at 50/60 Hertz sensing threshold (first beep).
The V-Watch will only detect AC voltage. Do not use below 2400 Volts.
- Typical Warning Distance: 7 feet (2.13 m.) from a 4kV AC conductor.
- Operating Temperature: -20? to +120?F (-29? to 49?C)
- Battery: 9V alkaline 1604A, IEC 6LR61. Life is 2 years in storage, one year typical usage.
- Beeper Sound Pressure Level: 100 decibels
- Water Withstand: Protected from falling rain per IEC-529, Level 2
- Weight (with battery): 5.2 oz. (147 g.)
- Dimensions: 3.5" x 2.88" x 1.25" (8.89 cm. x 7.32 cm. x 3.18 cm.)

Ordering Information

Model	DESCRIPTION
VW-20H	V-Watch Personal Voltage Detector with self-test function, yellow color, includes C-10 carrying case lanyard, 9V alkaline battery, and instruction booklet and instruction card.
VW-20H-K	V-Watch Kit includes VW-20H, C-10 carrying case lanyard and VW-K-BAG zippered carrying bag.
VWP-20H	V-Watch Pro Personal Voltage Detector with mute button (turns off audible for 5 minutes), self-test function, orange color, includes C-10 carrying case lanyard, 9V alkaline battery, instruction booklet and instruction card.
VWP-20H-K	V-Watch Pro Kit includes VWP-20H, C-10 carrying case lanyard and VW-K-BAG zippered carrying bag
C-10	Shielded carrying case with built-in lanyard for V-Watch Units
VW-K-BAG	Orange zippered carrying bag holds V-Watch unit, C-10 carrying case lanyard and instruction manual.

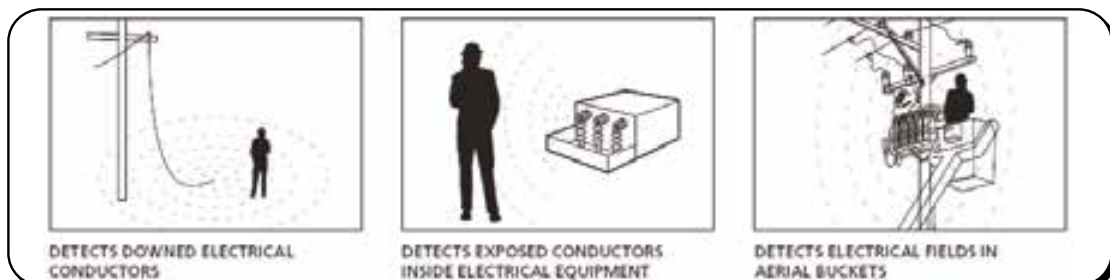

ULTRASONIC DETECTION / INFRARED CAMERA

Ultraprobe: Ultrasonic Detection

Application

Partial Discharge Inspection Equipment is deployed in all kinds of industry as follows :

- Utilities : electricity production and distribution
- Research and Development center : problems analysis
- Contractors : electrical services

ULTRAPROBE Ultrasound Inspection Systems have sensing high frequency emissions and use most any industry, including general manufacturing, processing, power generation and distributio printing and transportation. Typical applications include:

- Leak detection
- Aircraft inspection
- Bearing and mechanical inspection
- Electrical inspection such as arcing, tracking, corona and partial discharge detector



Model available

ULTRAPROBE 550 : analog ultrasonic inspection system

ULTRAPROBE 2000 : analog ultrasonic inspection system with frequency selection 20 kHz–100 kHz

ULTRAPROBE 3000 : digital ultrasonic inspection system

ULTRAPROBE 9000 : digital ultrasonic inspection system with frequency selection 20 kHz–100 kHz

ULTRAPROBE 10000 : advanced ultrasonic inspection system with analysis software

Infrared Camera

SP Thermoview P9 Camera

- Video output: PAL / NTSC composite video
- Spots analysis and isotherm
- Memo recorder up to 60 seconds per file
- Over 3 hours battery life
- External display: 2.47 inch color LCD
- Digital video: 1600 x 1200 ware color
- Measuring range: -20C to +250C (Up to +350C optional)
- Storage: Internal memory and external on 2 GB Mini-SD
- Video recording up to 30 minutes
- Class 2 semiconductor laser
- Safety class: IP54

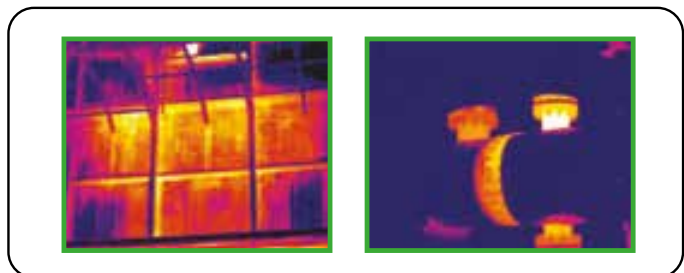

ULIRVISION

CORONA CAMERA

ULIRVISION's Corona Camera

TD100 is the latest Solar-blind UV camera which enables optical detection of UV signal in full daylight. With the high sensitivity to UV in the solar blind range, it is a powerful tool for detecting weak UV signals from long distance.



Technical Specifications

UV - Optical properties

UV sensitivity	2.2×10^{-18} watt/cm ²
Minimum discharge detection	1 pC @ 10m
Minimum RIV sensitivity	3.6 dB μ V @ 1MHz
Spectral range	240-280nm
FOV	7.2° x 5.4°
Focus	Auto/Manual
Resolution	640 x 480
Zoom	2x, 4x(optional)
Focus range	1.5m-∞

Visible - Optical properties

Minimum visible light sensitivity	0.1 Lux
Zoom	12x(Digital), 10x(Optical)

Image Performance

Image display	Sun proof color LCD 5", 800x480
Display brightness	Over 450cd/m ²
Image modes	Visible/UV/Combine
UV/Visible overlay accuracy	< 1 milliradian

Image Storage

Image format	JPG
Video format	AVI
Media download	Via Card Reader, USB, WIFI SD Card
Audio	Stored with image
Playback	Video/Pictures/Audio
SD card	Removable SD card 32GB
Software upgrade	Via files downloaded from website to SD Card
Storage capacity	1000+ images or >1 hr video/1GB

Output Interface

Video output	CVBS/HDMI(optional), PAL
Micro USB	Data transfer, communication
USB	USB WIFI

Power System

External power	DC: 9V-12V
Battery type	Rechargeable Li-Ion
Operating runtime	4hours

Physical Characteristics

Size	290mmx136mmx86mm
Weight	1.5kg

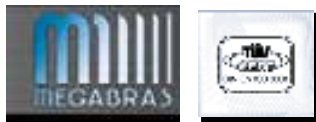

ELECTRICAL MEASUREMENT INSTRUMENTS

MEGABRAS INSTRUMENT



MD-5075x - 5kV INSULATION TESTER

- Insulation resistances up to 5 TΩ
- Digital & bar-graph reading
- Automated tests:
 - Absorption index
 - Polarization index
 - Capacitance
 - Leakage current
 - AC/DC voltmeter
- Chronometer up to 90 minutes
- Built-in printer
- Isolated RS-232 data port
- Software for data management
- Rechargeable battery

Price : 180,000 ₪



MPK-2000e - 10A DIGITAL MICRO-OHMMETER

- Microprocessor controlled
- 0,1μΩ resolution
- 4 _ digits reading
- Alphanumerical display
- Rechargeable battery
- 0,10% basic accuracy
- Kelvin-type (4-wires) measurement
- Offset free reading
- RS-232 data output
- IP-54 protection
- Resistance reading up to 200Ω

Price : 187,000 ₪



EM-4055 - EARTH RESISTANCE TESTER

- Earth resistance measurement
- Ground resistivity
- 0.01 Ω resolution
- Up to 20 kΩ resistance range
- Auto-range
- Alphanumerical display
- Rechargeable battery
- Built-in printer (optional)
- Direct reading of ground resistivity
- Up to 50 m selectable distance
- 4000 readings memory
- RS-232 data output
- IP-54 protection
- CE mark

Price : 169,000 ₪



MI-15Kve - HIGH VOLTAGE MEGOHMMETER

- Insulation test up to 3.000.000MΩ
- 4 test voltages:
 - kV - 5 kV - 10 kV - 15 kV
- Guard terminal
- Rechargeable battery
- Multiple scales for precision improvement
- Portable, accurate & rugged
- IP-54 protection
- CE mark

Price : 360,000 ₪



MPK-204e - 200A PORTABLE DIGITAL MICRO-OHMMETER

- Microprocessor controlled
- Alphanumerical display
- Resolution down to: 0,1 μΩ
- Resistance reading up to: 200 Ω
- Up to 200 A test current
- Kelvin-type (4 - wires) measurement
- Powered by internal battery or main supply
- Direct reading (up to 4¹/₂ digits)
- Overheating protection
- Serial data output (RS-232)
- Lightweight (16 kg)

Price : 638,000 ₪



MTD-20KWe - EARTH RESISTANCE TESTER

- Digital and automatic
- 3¹/₂ digits display
- Earth resistance measurement
- 4 pole ground resistivity (Wenner's method)
- Spurious voltage measurement
- High Spurious voltage rejection
- Audible signal indicated anomalies in the current circuit
- Resolution: 0,01Ω
- Up to 20 kΩ resistance range
- Rechargeable battery
- Battery check

Price : 132,000 ₪

GROUP G

STREET LIGHTING & ACCESSORIES SEALING COMPOUND LOW VOLTAGE FUSE SYSTEM



GROUP G
STREET LIGHTING,
RELAY LV FUSE
GK INSULATING



STREET LIGHTING LUMINAIRE LIGHTING CONTROL RELAYS



Street Lighting Luminaire & Accessories	Price / ราคา
Street Lighting 2x36W	3,000.00
Pipe Arm 1 1/2" x 2500mm.	800.00
Adjustable Bracket 1 1/2"	600.00



Photo Control 3 prong turn-lock 1800 VA			
Type	Rated V	Turn-on Lux	Price / ราคา
PS 1621-0454	20	15	550.00
PS 2040-0412	105 - 285	20	550.00

Type	Rated V	Rated A	Price / ราคา
AS-06	220	6A	500.00

Locking Type Receptacle for mounting on pole			
Type	Rated V	Rated A	Price / ราคา
M2A	120-600	15A at 120V, 10A at 240V, 5A at 480V	900.00

Locking Type Receptacle			
Type	Rated V	Rated A	Price / ราคา
GR-S-240	120-600	15A at 120V, 10A at 240V, 5A at 480V.	400.00



Type A Single Pole (with Photo Control Mounting)			
Type	Rated V	Rated A	Price / ราคา
1035 A	220	35	4,000.00
1060 A	220	60	4,800.00
1100 A	220	100	โปรดสอบถาม
1150 A	220	150	โปรดสอบถาม

Type B Single Pole			
Type	Rated V	Rated A	Price / ราคา
1035 B	220	35	3,000.00
1060 B	220	60	4,000.00
1100 B	220	100	โปรดสอบถาม
1150 B	220	150	โปรดสอบถาม

Type B 2 Pole			
Type	Rated V	Rated A	Price / ราคา
2035 B	220	35	7,000.00
2060 B	220	60	9,000.00
2100 B	220	100	โปรดสอบถาม
2150 B	220	150	โปรดสอบถาม

Type B 3 Pole			
Type	Rated V	Rated A	Price / ราคา
3035 B	220	35	10,000.00
3060 B	220	60	15,000.00
3100 B	220	100	โปรดสอบถาม
3150 B	220	150	โปรดสอบถาม



STREET LIGHT LUMINAIRE 70W & LED Street Light

STREET LIGHTING LUMINAIRE 70W

The High Pressure Sodium STREET LIGHT LUMINARIES 70W are designed follow up TIS standard and application for road lighting and outdoor. The STREET LIGHT LUMINAIRE 70W body made from aluminium and clear plastic cover. The device has light intensity more than 2.1 lux.



* Other power rating is available upon request

General Specification	
Type	LM 1.70 C
Power	70 W
Input Voltage	220 - 240 VAC
Frequency	50 Hz
Emitted Color	Bronze
Power Factor	> 0.85
Net Weight	~ 3.5 kg
IP Rating	IP65
Lifetime	More than 25,000 hrs
Price	8,000.00

STREET LIGHT LUMINAIRE 70W set

1. Luminaire with High Pressure Sodium lamp 70watt
2. Wire Cable
3. Luminaire Pole
4. Base

LED Street Light (2 x 18W)



The Street Lighting with LED Lamp is designed for outdoor installation with "ECO ENERGY" concept for energy saving

T8 LED Specification	
Size	Ø 28 x 1,214 mm.
Input Voltage	100 - 240 VAC
Frequency	50 / 60 Hz
Rated Power	18 W
Power Factor	> 0.9
Life Time	30,000 Hrs
Operatng Temp	-20 ~ +40C

Comparison Table for Lamp Properties Comparing (Actual Measurement)

ITEM	Fluorescent Lamp	LED Lamp
Type of Lamp Picture		
Input Voltage	220 V	220 V
Current	0.7 A	0.2 A
Power Factor	0.51	0.96
Power (Watts)	78 W	37 W
Frequency	50 Hz	50 Hz
Luminously	985 Lux	1,668 Lux
Life Time	16,000 Hrs.	30,000 Hrs.
LED Lamp is saving energy >50% compared with Fluorescent Lamp		

STREET LIGHTING SOLAR CELL

GUNKUL TYPE SCL

โคมไฟถนนชนิดใช้พลังงานแสงอาทิตย์

คุณสมบัติทั่วไป

- ใช้แผงโซลาร์เซลล์ในการแปลงพลังงานแสงอาทิตย์เป็นพลังงานไฟฟ้าจ่ายให้กับโคมไฟ
- การติดตั้งทำได้ง่ายสะดวกไม่ต้องใช้แหล่งจ่ายไฟจากภายนอก
- สามารถควบคุมการทำงานได้ทั้งระบบปิด - เปิดเอง และระบบอัตโนมัติ
- ชุดควบคุมและแบตเตอรี่บรรจุอยู่ในตู้ป้องกันน้ำและฝุ่น
- อุปกรณ์ควบคุมประจุแบตเตอรี่มีระบบป้องกันการประจุ และการคายประจุมากเกินไป ของแบตเตอรี่ช่วยให้แบตเตอรี่มีอายุการใช้งานยาวนาน
- เหมาะกับการใช้งานตามหมู่บ้านห่างไกลเพื่อให้แสงสว่างบริเวณบ้าน บริเวณทางเดินถนน สวนสาธารณะ บริเวณที่จอดรถและบริเวณต่างๆ ที่ต้องการแสงสว่าง



Specification

	SCL-F36-001	SCL-F36-002	SCL-F36-003	SCL-F36-004
ความสูงของเสา	5 M	5 M	5 M	5 M
แรงดันระบบ	12 VDC	12 VDC	12 VDC	12 VDC
ชนิดของหลอดไฟ	FL 36 W.	FL 36 W.	FL 36 W.	FL 36 W
ขนาดแผงรับพลังงานแสงอาทิตย์	75 Wp	80 Wp	120 Wp	160 Wp
เวลาการประจุแบตเตอรี่ (โดยประมาณ)	6.4 hr.	6 hr.	4 hr.	3 hr.
ความจุแบตเตอรี่	65 Ah.	80 Ah.	90 Ah.	100 Ah.

COMPOUND AND ACCESSORIES

INTELTROX ANTI-OXIDE COMPOUND

Contains zinc particles in viscous element to ensure low-resistance electrical connections. When spread on the conductor the INTELTROX breaks the oxide film that builds up after brushing and assembles a considerable number of conducting bridges. Its anti-oxidizing action (amine type) and insolubility in water, gas and oil makes the connection free from air and moisture therefore, preventing corrosion and oxidation. The use of INTELTROX is mandatory on all Al-Al and Al-Cu connections.



Cat. No.	Size	Price / ราคา
INTELTROX ANTI-OXIDE COMPOUND	Net Weight 250 g	800.00

AIRSEAL Insulating pad

(ฉนวนห่อหุ้มจุดต่อป้องกันออกไซด์, ความชื้นและคลื่นรบกวน)

- Protected oxide and moisture to connector
- Insulated to all connections
- Molded around any sharp connection to protect radio noise interference



Cat. No.	Pad Size (inch)	Packing	Price / ราคา
18415-0	4 x 4 x 1/8	1	85.00
18415-8	4 x 4 x 1/8	25	1,680.00



Type	Packing Bags	Price / ราคา
DS-1	1 Lb.	150.00
DS-5	5 Lb.	600.00



Cat. No.	Width (inch)	Length (ft)	Colour	Price / ราคา
YT6	6	1000	Yellow	3,000.00
RT6	6	1000	Red	3,000.00

LOW VOLTAGE FUSE



ADAPTER

D FUSE

D-CARTRIDGE FUSE

FUSE CAP

H.R.C.FUSE LINK

Adapter

อแดปเตอร์

E27	A	2	4	6	10	16	20	25	E33	35	50	63
Price ราคา	20.00								Price ราคา	25.00		

D Fuse

ลูกฟิวส์

E27	A	2	4	6	10	16	20	25	E33	35	50	63
Price ราคา	20.00								Price ราคา	25.00		

D-Cartridge Fuse (Aerial fuse holder)

คาถริดจิวส์กันฝน

GUNKUL
we only like energy, we care

Type	Price
Gunkul Cartridge Fuse	ราคา
E27-25A	380.00
E33-63A	480.00

Fuse Cap (Screw Cap)

กระจุก

GUNKUL
we only like energy, we care

Type	Price	
	ราคา	
Standard (กลม)	E27	30.00
Star Model (จีบ)	E27	30.00
Standard (กลม)	E33	36.00
Star Model (จีบ)	E33	36.00

H.R.C.Fuse Link

A	Price / ราคา Size 00	Price / ราคา Size 1	Price / ราคา Size 2	Price / ราคา Size 3
6	108.00	-	-	-
10	108.00	-	-	-
16	108.00	-	-	-
20	108.00	-	-	-
25	108.00	-	-	-
32	108.00	-	-	-
40	108.00	-	-	-
50	108.00	-	-	-
63	108.00	-	-	-
80	108.00	216.00	-	-
100	118.00	216.00	348.00	-
125	118.00	216.00	348.00	-
160	118.00	216.00	348.00	-
200	-	216.00	348.00	-
250	-	216.00	348.00	-
315	-	-	348.00	-
400	-	-	348.00	516.00
500	-	-	-	516.00
630	-	-	-	516.00



LV H.R.C. Load Break Switch
โหลดเบรคสวิทช์แรงต่ำ

Type	Size	A	Price / ราคา
Terminal	00	160	2,160.00
Clamp			2,280.00
Terminal	1	250	5,040.00
Clamp			5,160.00
Terminal	2	400	6,600.00
Clamp			6,840.00
Terminal	3	630	7,200.00



Triple Pole Fuse Bases
ฐานฟิวส์สามสาย

Type	Size	A	Price / ราคา
Terminal	00	160	576.00
Clamp			625.00
Terminal	1	250	1,620.00
Clamp			1,860.00
Terminal	2	400	2,640.00
Clamp			2,880.00



Single Pole Fuse Bases
ฐานฟิวส์เดี่ยว

Type	Size	A	Price / ราคา
Terminal	00	160	162.00
Clamp			174.00
Terminal	1	250	384.00
Clamp			456.00
Terminal	2	400	576.00
Clamp			660.00
Terminal	3	630	840.00



Fuse Pulling
ด้ามดึงฟิวส์ใบมีด

Type	For Fuse Size	Price / ราคา
H.R.C.	00, 1, 2, 3	480.00



Fuse Bases
คาทริดจ์ฟิวส์ลอย

Type	A	Price / ราคา
E 27	25	150.00
E 33	63	240.00



Switch Board Fuse
คาทริดจ์ฟิวส์ฝังในตัว แบบกรอบกลม

Type	A	Price / ราคา
E 27	25	135.00
E 33	63	180.00



Switch Board Fuse
คาทริดจ์ฟิวส์ฝังในตัว แบบกรอบเหลี่ยม

Type	A	Price / ราคา
E 27	25	145.00
E 33	63	205.00



Switch Board Fuse
คาทริดจ์ฟิวส์ใส่รางในตัว แบบกรอบกลม

Type	A	Price / ราคา
E 27	25	145.00
E 33	63	205.00



Switch Board Fuse
คาทริดจ์ฟิวส์ใส่รางในตัว แบบกรอบเหลี่ยม

Type	A	Price / ราคา
E 27	25	145.00
E 33	63	205.00

GROUP H

SERVICE & MAINTENANCE





DILO CONCEPT FOR THE RE-USE OF SF₆ - GAS

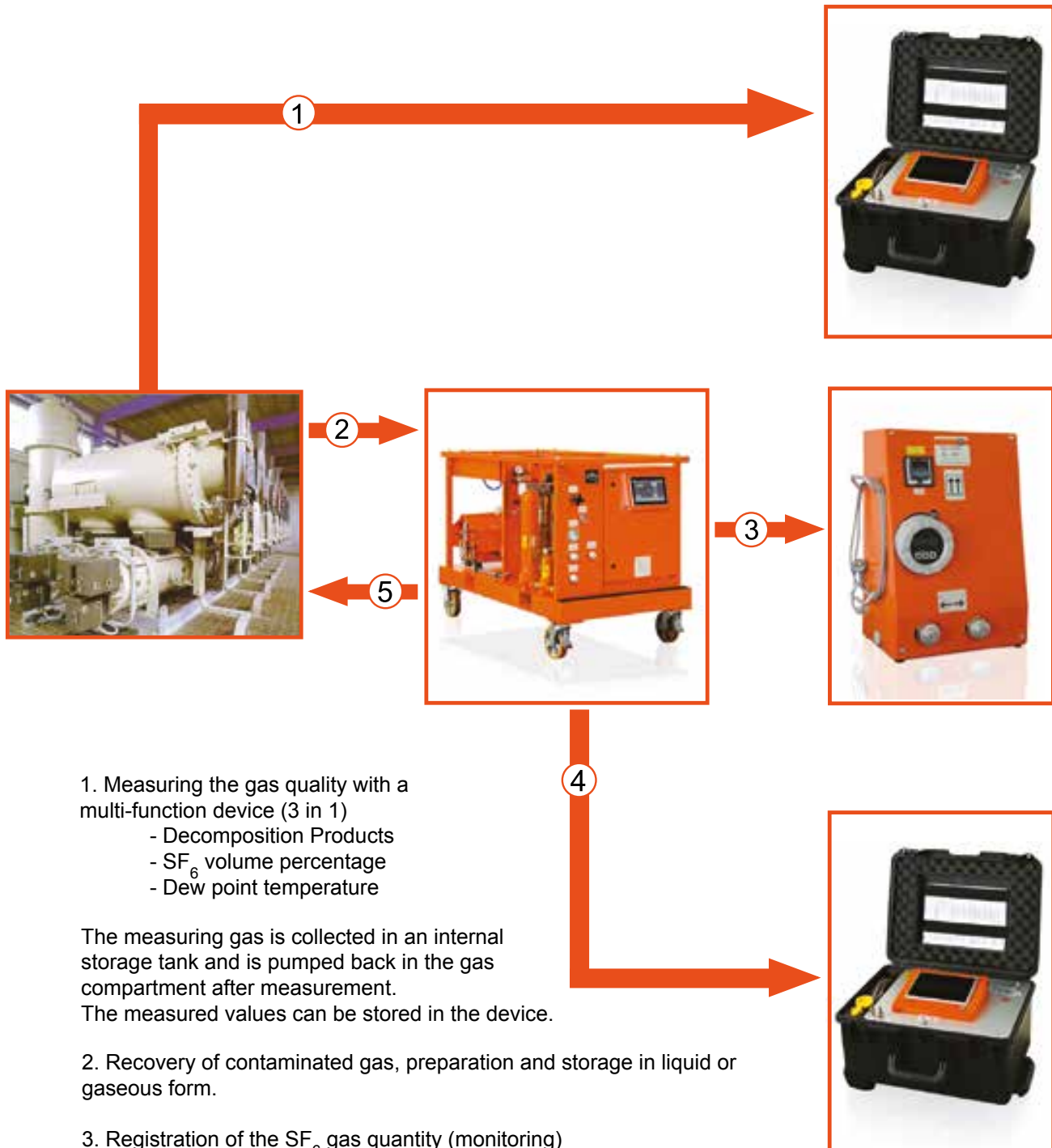

1. Measuring the gas quality with a multi-function device (3 in 1)
- Decomposition Products
 - SF₆ volume percentage
 - Dew point temperature

The measuring gas is collected in an internal storage tank and is pumped back in the gas compartment after measurement. The measured values can be stored in the device.

2. Recovery of contaminated gas, preparation and storage in liquid or gaseous form.

3. Registration of the SF₆ gas quantity (monitoring)

4. Measurement of the prepared gas (see item1)
Collecting the measuring gas and pumping it back in the storage tank.

5. If the purified SF₆ gas does not exceed the limit values of the IEC 60480 directive so it is allowed to reused.

SF₆ - SERVICE AND MEASURING DEVICES

The Mini Series

The Mini series is only recommended for the treatment of small gas quantities

Mini Series B143

- For the liquid and gaseous storage
- Portable as individual component
- With transport case
- With touch panel



Mini Series B143



Vacuum Compressor unit



Compressor Unit



Vacuum Pump Unit



Pre-Filter Unit

Economy and Compact Series



Piccolo Series L030

- Combined unit for liquid and gaseous storage
- With removable vacuum pump unit

Economy Series

- Operation and Indication of the most important process parameter via 10" touch panel
- For simple, trouble-free gas handling
- For liquid storage
- Available in different tank sizes
- Oil-free recovery of SF₆ down to 1mbar





SF₆ - SERVICE AND MEASURING DEVICES



SF₆ gas refilling and evacuating device

- 16 m³/h vacuum pump for air
- Couplings DN8 and DN20
- Gauge 0 – 1,200 mbar
- Pressure reducer 0 – 10 bar
- Electronic weighing device 0 – 150 kg as an option

MIRROR Analyser

- For measurement of SF₆ volume percentage and moisture in gas-insulated switchgear.
- Measuring range: -50 °C up to +20 °C
- Input pressure: Pe 0.2 bar – 35 bar
- Internal storage vessel with gas recovery system
- USB interface

SF₆ Network Monitor

- Central monitoring and administration of SF₆ air sensors connected
- Recording of measuring values
- Setting of limit values for warning and alarm for each SF₆ air sensor connected

SF₆ Multi-Analyser with/without gas return system

Allow to determine the three most important parameters for reuse of SF₆ gas with only one measurement:

- SF₆ concentration (%)
- Moisture concentration
- SO₂ concentration (ppm_v), Option: HF concentration (ppm_v)

SF₆ gas leak detector

Measuring principle: ion-vacuum principle

- For quick detection of gas leakages
- Sensitivity: 3g SF₆/year



High Pressure Tube Unions



SF₆ - valves and coupling

Nickel-Cadmium (NiCd) Industrial Batteries

Alcad has more than 100 years' experience in the development & manufacture of pocket plate cells and batteries. Alcad single cells conform to IEC and DIN standards. The comprehensive range of cells gives Alcad an unequalled product range. There are two series of batteries: H, M, L Series and Low Maintenance Series.



Battery Series	H, M & L Batteries			Low-Maintenance	
Battery Types	LCP	MCP	HCP	VN	XHP
Capacity Range (Ah)	10-1540	9-1390	9-920	8-476	11-320
Use of Batteries	Power back-up & storage	Power back-up	Starting & power back-up	Power back-up	Starting & power back-up
Applications	Engine starting, switchgear, UPS, process control, data and information, emergency lighting, security and fire alarms, switching and transmissions, signaling				
Utilities: electricity, gas, water production and distribution	Yes	Yes	Yes	Yes	Yes
Oil and gas: offshore and onshore, petrochemical and refineries	Yes	Yes	Yes	Yes	Yes
Industry: chemical, mining, steel	Yes	Yes	Yes	Yes	Yes
Buildings: security & fire alarms, emergency lighting, lift control	Yes	Yes	Yes	Yes	Yes
Medical: hospitals, X-ray equipment	Yes	Yes	Yes	Yes	Yes
Telecom: radio, satellite, cable, repeater & cellular base stations	Yes	Yes	Yes	Yes	Yes
Railways: substations and signaling	Yes	Yes	Yes	Yes	Yes
Airports	Yes	Yes	Yes	Yes	Yes

Please kindly provide Application, Capacity and Voltage Level in order to supply the most suitable type of battery.

SYLGARD

HIGH VOLTAGE INSULATOR COATING

HIGH VOLTAGE INSULATOR COATING

(ซิลิโคนพิเศษเคลือบลูกถ้วย)



ป้องกันไฟฟ้าดับด้วย HVIC COATING

ปัญหาลมภาวะในอากาศส่งผลกระทบต่อสายส่งจ่ายพลังงานไฟฟ้า เมื่อใดก็ตามที่ลูกถ้วยไฟฟ้าแรงสูงถูกใช้อยู่ภายใต้สภาพอากาศที่มีมลภาวะ เช่น ไอเกลือ และ ฝุ่นผงจากอุตสาหกรรมหรือสารเคมี ปัญหา Flashover บนฉนวนลูกถ้วยสามารถเกิดขึ้นได้เสมอหากลูกถ้วยนั้นไม่ได้รับการป้องกันอย่างถูกวิธี

ปัญหา Flashover ดังกล่าวหมายถึง ปัญหาไฟฟ้าดับและส่งผลกระทบต่อระบบการผลิตในอุตสาหกรรม ซึ่งสามารถป้องกัน Flashover ด้วย “High Voltage Insulator Coating”

Model	Packing	Price / ราคา
XIAMETER ECE-3650 SYLGARD HVIC	Can. 1 kg.	7,800.00/kg
	Can 5 kg.	7,000.00/kg
	Can 20.4 kg.	6,000.00/kg
“3099” High Voltage Insulator Compound (HVIC 3099)	Can 20.4 kg.	6,000.00/kg
NAPTHA Solvent	Can. 1 liter.	150.00/litr

Dow corning HVIC เป็นสารเคลือบฉนวนลูกถ้วย เพื่อป้องกันการเกิด Flashover ลดปัญหาไฟดับ โดยเฉพาะในสภาพแวดล้อมที่มีมลภาวะสูง



OIL PURIFIER DEVICES



Oil Purifying Plant

APPLICATION

Oil purifier machines are deployed in all kinds of industry, worldwide.

Utilities : electricity production and distribution

Industries : electrical service or maintenance

Companies : consulting services

Laboratories : electrical equipment testing

PRODUCT DETAIL

Oil purification plant for improving oil insulation and dielectric properties. Oil purification plant can remove trace water, gas, particles, etc. from the insulating oil effectively and rapidly boost performance of transformers, circuit breakers, etc. which has oil insulation system. The Oil Purifier could be supplied in either Skidding type with / without enclosure or Mobile type which equipped with mono-axle trailer & tyres.

There are two types of Oil Purifier Machines as follows :

- Single Stage Vacuum System with one vacuum pump
- Double Stage Vacuum System with two vacuum pump for faster operation

We also supply several kinds of waste oil regeneration equipment such as transformer oil recycling system, lubricating oil purification plant, turbine oil filtration plant, fuel oil purifier, engine oil reclamation, etc.

Specification		
Flow rate	L/H	600
Vacuum range	MPa	-0.092 to -0.096
Working pressure	MPa	≤ 0,5
Max vacuum range	Pa	≤ 100
Temperature range	°C	45 – 65
Water content	PPm	≤ 7
Gas content	%	≤ 0,1
Power supply	V	380 V / 50 Hz
Working noise	dB	≤ 72
Heating power	kW	12
Total power	kW	14
Inlet diameter	mm	DN20
Outlet diameter	mm	DN20
Net weight	kg	700
Size Length	mm	2500
Width	mm	1600
Height	mm	1750

Other model & capacity is also available



STRINGING EQUIPMENT

We offer a broad range of Stringing Equipments for Construction and Maintenance of Transmission and Distribution Electrical line as well as Telecommunication line. The machines and tools are suitable for stringing and tensioning cables in various applications such as:

- High Voltage overhead transmission lines
- Medium Voltage distribution lines
- Fiber optic lines (OPGW)
- Underground cables

Stringing Equipment are included Hydraulic Puller, Hydraulic Tensioner, Winches, Light Alloy Structure, Gin Poles, Stringing Blocks and accessories.



Stringing Equipment Guide

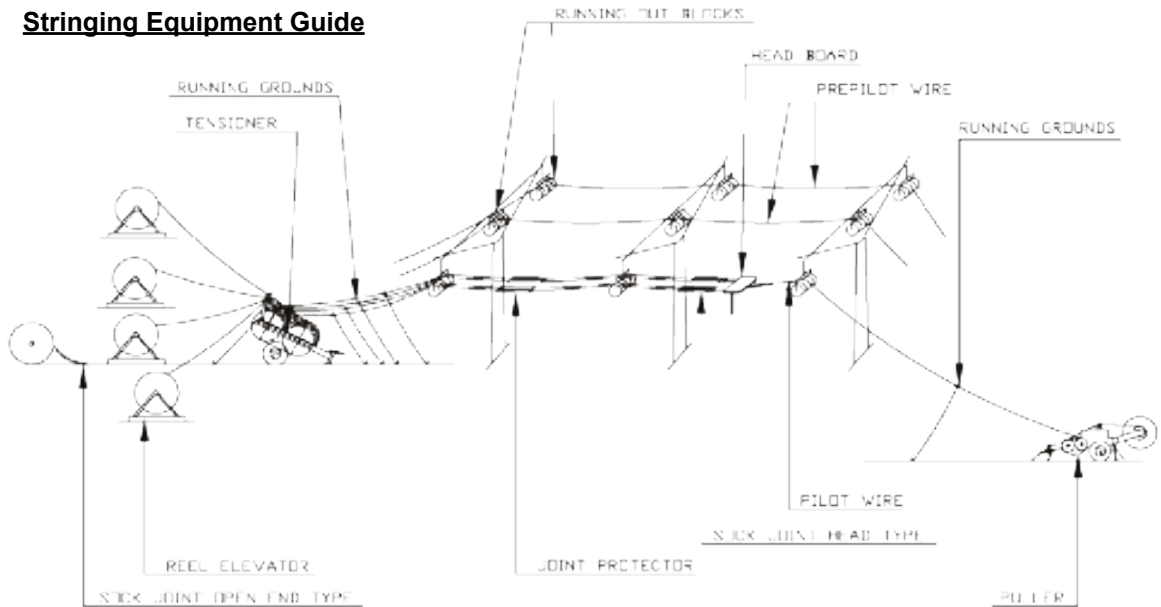

Tools and accessories



Hydraulic reel elevator



Hydraulic reel winders



Cradle reel elevator



Antitwisting steel rope



Sock Joints



Stringing blocks



Nylon Ropes



Thermometers



Running boards



STRINGING EQUIPMENT

Hydraulic Puller from 2 to 250 kN



- All TE.M.A. pullers have the incorporated reel winders for pilot ropes reels.
- Diesel engines with electric/electric control panel.
- The reel winders guarantee the correct counter pull necessary safety pulling operations.
- All Te.m.a. pullers are equipped with pull control devices to guarantee the safety during the stringing operation.

Hydraulic Tensioner from 2 to 250 kN



- All TE.M.A. tensioners have the replaceable nylon sectors.
- Diesel engines with electric/electric control panel.
- A Hydraulic system allows a constant tensioning force, independently from the speed.
- Twin, triple and four bundle tensioner, allow independent control for each conductor.
- All the tensioners can be fitted with engine for pull back operations.

Hydraulic Puller-Tensioners from 2 to 250kN



- TE.M.A. machines are made with a hydraulic system for pull setting and control; to increase the safety factor.
 - Diesel engines with electric/electric control panel.
 - The machines are provided with:
 - (a) Hydraulic circuit able to detect the tension on the ropes and conductors.
 - (b) Presetting pull control device.
- These two features allow the machine to, automatically stop the stringing operation if the tension on the conductors reaches the presetting pull value.

Gin poles

- ALUMINIUM GIN POLE for hoisting operations, during poles and steel towers erections.
- Supplied with two or more sections, in aluminium alloy tubular lattice structures by welding operations in (TIG SYSTEM).
- Working capacity on head "PN" from 1,000 to 10,000daN, length from 6 to 22m with swivelling head and base, complete of base ground plate and tower hook till to 5,000 daN capacity structures with EXTERNAL or INTERNAL wire rope passage.



GROUP I

CONDUIT FITTING, HDPE, EFLEX & CABLE GLAND



SHIMADA ELECTRIC (JAPAN) EXPLOSION PROOF EQUIPMENTS



Flame Proof Type Junction Boxes

Certified by : ATEX / CENELEC

EExd II B T6 / EExd II B / IP-66

Material : Aluminum Alloy Casting



Increased Safety Type Junction Boxes

Certified by : ATEX / CENELEC

EExe II T6 / EExe II / IP-66

Material : Aluminum Alloy Casting



Increased Safety Type Junction Boxes

Certified by : ATEX / CENELEC

EExe II T6 / EExe II / IP-66

Material : Stainless Steel 304 & 316

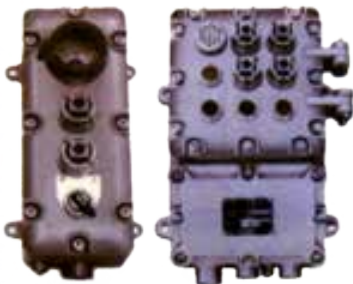

Flame Proof Explosion Protected Control Boxes

Protection Standard : JIS d2G4 / JIS eG4

Material : Aluminum Alloy Casting

(Japanese Industrial Standard)

EXPLOSION PROOF PACKING TYPE CABLE GLAND (d2G4)

Material : Brass with Electroplating (16~28)
Copper Alloy with Electroplating (36~104)
Stainless Steel is available upon request



**Flame-Proof Explosion-Protected Cable Gland (d2G4)
Type NSTPC-B (Outdoor) Male x Female Thread**

TYPE	Tapered thread NPT inch	Applicable Cable Size	∅D	S1	S2	B	∅C	(L)	Price บาท
NSTPC-16B	1/2	7.0~12.0	13	21	17	36	39	92	4,400.00
NSTPC-22B	3/4	12.0~16.0	17	21	17	41	45	92	5,500.00
NSTPC-28B	1	16.0~20.0	22	25	19	46	50	102	8,300.00
NSTPC-36B	1-1/4	20.0~25.0	31	23	25	60	65	125	12,700.00
NSTPC-42B	1-1/2	25.0~29.0	37	23	25	71	75	132	16,500.00
NSTPC-54B	2	29.0~37.0	48	23	25	88	93	133	25,300.00
NSTPC-70B	2-1/2	37.0~47.0	60	27	30	105	110	156	36,300.00
NSTPC-82B	3	47.0~56.0	72	27	32	123	128	162	77,000.00
NSTPC-92B	3-1/2	56.0~64.0	84	27	45	134	140	186	214,500.00
NSTPC-104B	4	64.0~72.0	95	27	50	147	153	194	231,000.00



**Flame-Proof Explosion-Protected Cable Gland (d2G4)
Type NSTPC-R (Outdoor) Male x Bell Mouth**

TYPE	Tapered thread NPT inch	Applicable Cable Size	∅D	S1	S2	B	∅C	(L)	Price บาท
NSTPC-16R	1/2	7.0~12.0	13	21	17	36	39	92	4,400.00
NSTPC-22R	3/4	12.0~16.0	17	21	17	41	45	92	5,500.00
NSTPC-28R	1	16.0~20.0	22	25	19	46	50	102	8,300.00
NSTPC-36R	1-1/4	20.0~25.0	31	23	25	60	65	125	12,700.00
NSTPC-42R	1-1/2	25.0~29.0	37	23	25	71	75	132	16,500.00
NSTPC-54R	2	29.0~37.0	48	23	25	88	93	133	25,300.00
NSTPC-70R	2-1/2	37.0~47.1	60	27	30	105	110	156	36,300.00
NSTPC-82R	3	47.0~56.1	72	27	32	123	128	162	77,000.00
NSTPC-92R	3-1/2	56.0~64.1	84	27	45	134	140	186	214,500.00
NSTPC-104R	4	64.0~72.0	95	27	50	147	153	194	231,000.00

INCREASED SAFETY CABLE GLANDS (EEXE II) FLAMEPROOF CABLE GLAND (EEXD IIC)

Material : Brass with Electroplating
Threads : Tapered thread (NPT)
 Stainless Steel is available upon request

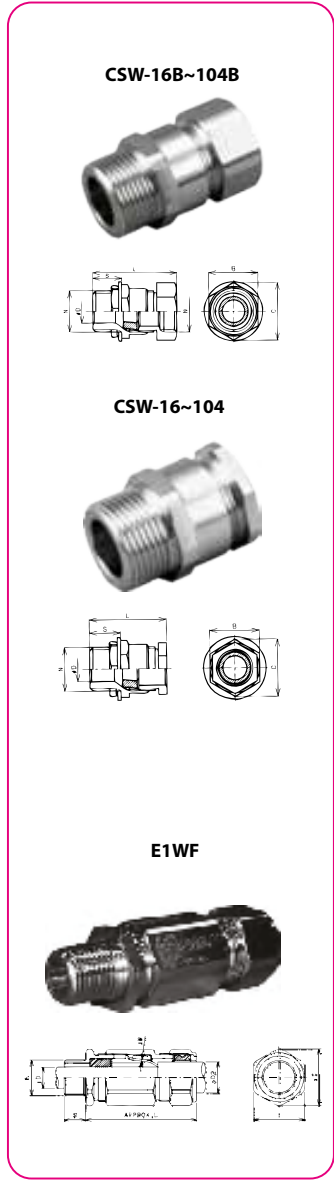

Industrial Type (Outdoor) Cable Gland
 Type CSW-B **Male Thread x Female Thread Type**

TYPE	Tapered thread NPT inch (N)	Applicable Cable Size \varnothing	$\varnothing D$	S	B	C	L	Price 1101
CSW-16B	1/2	9.1~13.0	15	19	25	31.2	62	2,000.00
CSW-22B	3/4	9.1~13.0	15	19	32	37	57	2,200.00
CSW-28B	1	13.1~18.0	20	21	38	43.9	61	2,500.00
CSW-36B	1-1/4	18.1~24.0	30	21	47	54.9	61	3,700.00
CSW-42B	1-1/2	24.1~30.0	34	21	53	61.5	63	5,200.00
CSW-54B	2	30.1~38.0	42	21	66	76.2	67	6,500.00
CSW-70B	2-1/2	38.1~50.0	54	23	82	94.7	68	12,100.00
CSW-82B	3	50.1~63.0	65	23	96	110.9	72	16,500.00
CSW-92B	3-1/2	63.1~75.0	77	23	109	125.9	76	19,800.00
CSW-104B	4	75.1~86.0	88	23	123	142.1	78	30,800.00

Industrial Type (Outdoor) Cable Gland
 Type CSW **Male Thread x O.D.**

TYPE	Tapered thread NPT inch (N)	Applicable Cable Size \varnothing	$\varnothing D$	S	B	C	L	Price 1101
CSW-16	1/2	9.1~13.0	15	19	30	34.5	54	1,700.00
CSW-22	3/4	9.1~13.0	15	19	30	34.5	49	1,800.00
CSW-28	1	13.1~18.0	20	21	38	44	51	2,300.00
CSW-36	1-1/4	18.1~24.0	30	21	46	53	51	3,100.00
CSW-42	1-1/2	24.1~30.0	34	21	52	60	51	4,000.00
CSW-54	2	30.1~38.0	42	21	64	74	56	5,000.00
CSW-70	2-1/2	38.1~50.0	54	23	80	92.5	56	9,400.00
CSW-82	3	50.1~63.0	65	23	93	107.5	54	13,200.00
CSW-92	3-1/2	63.1~75.0	77	23	105	121	66	16,000.00
CSW-104	4	75.1~86.0	88	23	119	138	68	23,700.00

Flame-Proof Explosion-Protected Cable Gland
 Type E1WF **For use with single wire armoured cable**

TYPE	Entry Thread Size NPT N	Cable Acceptance details				S	L	B	$\varnothing C$	Weight (kg)	Price 1101
		Diameter of Inner Sheath $\varnothing D1$	Diameter of Outer Sheath $\varnothing D2$		Wire armour diameter $\varnothing W$						
			1	2							
E1WF/N2R-1/2NPT	1/2NPT	3.0~8.0	-	5.5~12.0	0.9/1.25	20	80	30	33	0.25	3,900.00
E1WF/N2Q-1/2NPT		6.0~9.5	-	9.5~16.0							4,550.00
E1WF/N4A-1/2NPT		8.5~13.4	12.5~18.0	18.1~20.5							3,900.00
E1WF/N2A-1/2NPT	11.0~14.3	4,550.00									
E1WF/N4B-3/4NPT	3/4NPT	9.5~15.4	16.9~24.0	24.1~26.0	1.25/1.6	20	81	36	40	0.35	4,550.00
E1WF/N2B-3/4NPT		13.0~20.2									4,550.00
E1WF/N4C-1NPT		15.5~21.2									22.0~30.0
E1WF/N2C-1NPT	19.0~26.5	5,200.00									
E1WF/N4D-11/4NPT	22.0~28.0	28.0~38.0	38.1~41.0	1.6/2.0	23	101	55	60	0.9	9,750.00	
E1WF/N2D-11/4NPT	25.0~32.5									9,750.00	
E1WF/N4E-11/2NPT	27.5~34.8									36.0~44.0	44.1~52.6
E1WF/N4E-2NPT	2NPT	14,300.00									
E1WF/N2E-11/2NPT	1-1/2NPT	31.5~38.2	24,700.00								
E1WF/N2E-2NPT	2NPT	31.5~44.4	24,700.00								
E1WF/N4F-21/2NPT	2-1/2NPT	39.0~46.5	46.0~56.0	56.1~65.3	1.8/2.5	30	144	90	100	3.7	35,100.00
E1WF/N2F-21/2NPT		42.5~56.3									35,100.00
E1WF/N4G-3NPT		3NPT									48.5~58.3
E1WF/N2G-3NPT	3NPT	54.5~68.2	54,600.00								

INCREASED SAFETY CABLE GLANDS (EEXE II) FLAMEPROOF CABLE GLAND (EEXD IIC)

Material : Brass with Electroplating
Threads : Tapered thread (NPT)

Increased safety protection (EExe II) (Outdoor or Indoor) Cable Gland
Type CW For use with single wire armoured cable , Open-conduit System

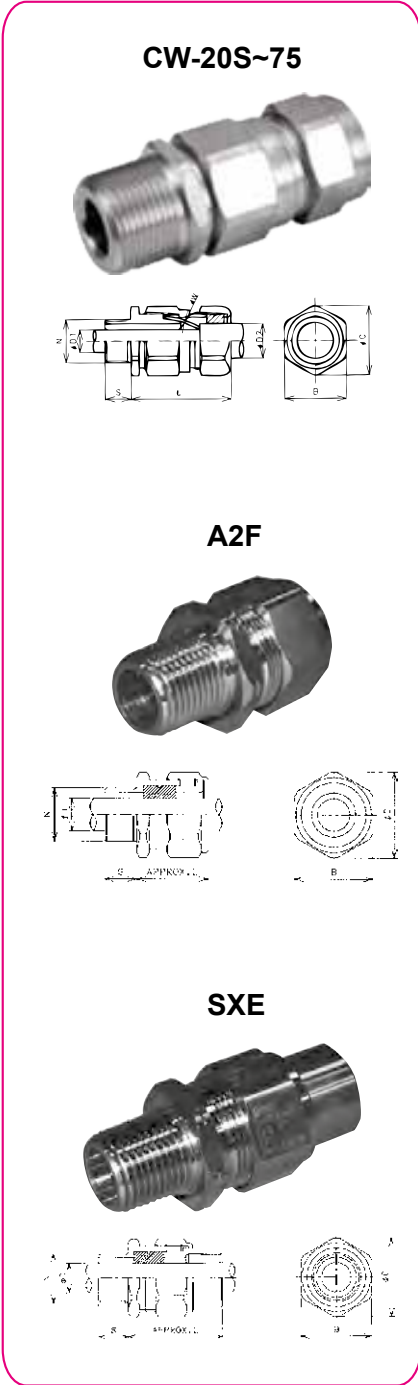

TYPE	Tapered thread NPT inch (N)	Applicable Cable Size			S	L	B	φC	Price ราคา
		INNER SHEATH φD1	OUTER SHEATH φD2	WIRE SIZE φW					
CW-20S	1/2	11.7	12.9~15.8	0.9 / 1.25	15	60	24	27	3,120.00
CW-20	3/4	14.0	15.5~20.8	0.9 / 1.25	15	60	30	33	3,380.00
CW-25	1	19.0	20.3~27.2	1.25 / 1.6	15	65	36	40	4,680.00
CW-32	1-1/4	26.3	26.7~33.5	1.6 / 2.0	15	70	46	50	6,760.00
CW-40	1-1/2	32.2	33.0~39.9	1.6 / 2.0	15	80	55	60	12,090.00
CW-50S	2	38.2	39.4~46.3	2.0 / 2.5	15	85	65	70	21,450.00
CW-50	2	44.1	45.7~52.6	2.0 / 2.5	15	85	65	70	21,450.00
CW-63S	2-1/2	50.1	52.1~58.9	2.5	15	85	80	85	32,500.00
CW-63	2-1/2	56.0	58.4~65.3	2.5	15	85	80	85	32,500.00
CW-75S	3	62.0	64.8~71.6	2.5	15	95	95	105	41,600.00
CW-75	3	68.0	71.1~78.0	2.5	15	95	95	105	41,600.00

Explosion protection (Outdoor or Indoor)
Type A2F For use with unarmoured cable (Male Thread + Open conduit)

TYPE	Entry Thread Size NPT N	Cable Acceptance details Diameter of Inner Sheath φD1	S	L	B	φC	"Weight (kg)"	Price ราคา
A2F/N2Q-1/2NPT	6.0~9.5	2,860.00						
A2F/N4A-1/2NPT	8.5~13.4	2,600.00						
A2F/N2A-1/2NPT	11.0~14.3	2,860.00						
A2F/N4B-3/4NPT	1/2NPT	9.5~15.4	20	33	36	40	0.16	2,860.00
A2F/N2B-3/4NPT		13.0~20.2						2,860.00
A2F/N4C-1NPT	1NPT	15.5~21.2	23	46	46	50	0.35	3,900.00
A2F/N2C-1NPT		19.0~26.5						3,900.00
A2F/N4D-11/4NPT	1-1/4NPT	22.0~28.0	23	46	55	60	0.5	5,850.00
A2F/N2D-11/4NPT		25.0~32.5						5,850.00
A2F/N4E-11/2NPT	1-1/2NPT	27.5~34.8	23	60	74	80	1.3	10,400.00
A2F/N4E-2NPT	2NPT							10,400.00
A2F/N2E-11/2NPT	1-1/2NPT	31.5~38.2	30	69	90	100	2.0	17,550.00
A2F/N2E-2NPT	2NPT	31.5~44.4						17,550.00
A2F/N4F-21/2NPT	2-1/2NPT	39.0~46.5	30	69	90	100	2.0	26,000.00
A2F/N2F-21/2NPT		42.5~56.3						26,000.00
A2F/N4G-3NPT	3NPT	48.5~58.3	32	71	108	115	3.0	32,500.00
A2F/N2G-3NPT		54.5~68.2						32,500.00

Cable Gland for Flexible tube Connection
Type (Male x Female Thread) NPT Thread

TYPE	Entry Thread Size NPT N	Cable Acceptance details Diameter of Inner Sheath φD1	S	L	B	φC	"Weight (kg)"	Price ราคา
SXE/N2Q-1/2NPT	6.0~9.5	2,860.00						
SXE/N4A-1/2NPT	8.5~13.4	2,600.00						
SXE/N2A-1/2NPT	11.0~14.3	2,860.00						
SXE/N4B-3/4NPT	3/4NPT	9.5~15.4	20	48	36	40	0.2	2,860.00
SXE/N2B-3/4NPT		13.0~20.2						2,860.00
SXE/N4C-1NPT	1NPT	15.5~21.2	23	66	46	50	0.45	3,900.00
SXE/N2C-1NPT		19.0~26.5						3,900.00
SXE/N4D-11/4NPT	1-1/4NPT	22.0~28.0	23	66	55	60	0.6	5,850.00
SXE/N2D-11/4NPT		25.0~32.5						5,850.00
SXE/N4E-11/2NPT	1-1/2NPT	27.5~34.8	23	85	74	80	1.7	10,400.00
SXE/N4E-2NPT	2NPT							10,400.00
SXE/N2E-11/2NPT	1-1/2NPT	31.5~38.2	30	94	90	100	2.6	17,550.00
SXE/N2E-2NPT	2NPT	31.5~44.4						17,550.00
SXE/N4F-21/2NPT	2-1/2NPT	39.0~46.5	30	94	90	100	2.6	26,000.00
SXE/N2F-21/2NPT		42.5~56.3						26,000.00
SXE/N4G-3NPT	3NPT	48.5~58.3	32	96	108	115	3.7	32,500.00
SXE/N2G-3NPT		54.5~68.2						32,500.00

CABLE GLANDS & CONDUIT FITTINGS

Material : Steel
Surface Treatment : Zinc, Electro plated

Flame-proof Explosion-Protected Union Coupling (d2G4)
 Type SUM (Male x Female)

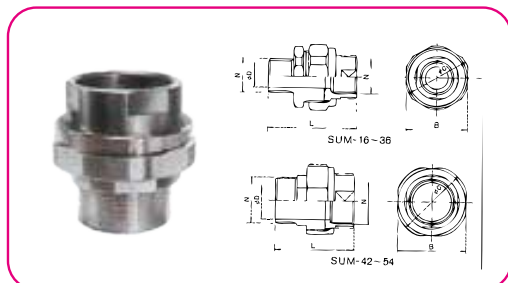

TYPE	Tapered thread NPT inch (N)	∅D	B	∅C	L	Price ₹/pcs
SUM-16	1/2	15	38	41	58	1,100.00
SUM-22	3/4	21	46	50	59	1,400.00
SUM-28	1	27	50	54	72	2,000.00
SUM-36	1-1/4	35	58	63	75	2,800.00
SUM-42	1-1/2	40	70	75	80.5	3,500.00
SUM-54	2	52	86	59	80.5	5,500.00
SUM-70	2-1/2	66	96	100	99	9,800.00
SUM-82	3	78	111	113	97	15,000.00
SUM-94	3-1/2	88	124	129	106	18,000.00
SUM-104	4	100	140	145	106	22,000.00

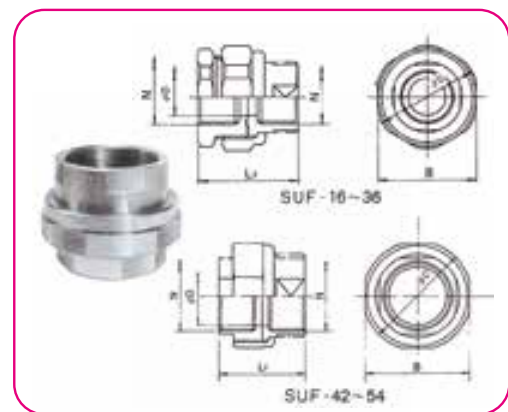

Flame-proof Explosion-Protected Union Coupling (d2G4)
 Type SUF (Female x Female)

TYPE	Tapered thread NPT inch (N)	∅D	B	∅C	L ₁	Price ₹/pcs
SUF-16	1/2	15	38	41	39	1,000.00
SUF-22	3/4	21	46	50	40	1,300.00
SUF-28	1	27	50	54	49	1,900.00
SUF-36	1-1/4	35	58	63	51.5	2,500.00
SUF-42	1-1/2	40	70	75	58.5	3,300.00
SUF-54	2	52	86	59	58.5	5,300.00
SUF-70	2-1-2	66	96	100	65	9,500.00
SUF-82	3	78	111	113	72	12,000.00
SUF-94	3-1/2	88	124	129	78	17,200.00
SUF-104	4	100	140	145	78	20,500.00

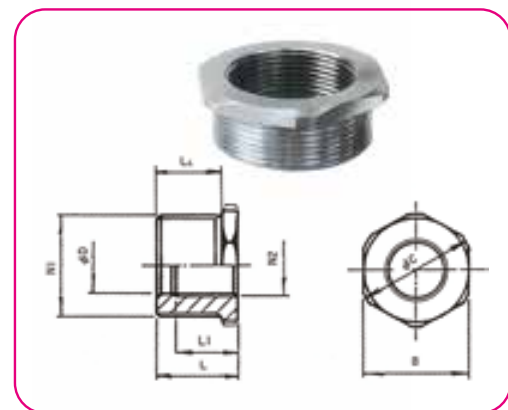

Flame-proof Explosion-Protected Adaptors (d2G4)
 Type SA Adaptors

TYPE	Tapered thread NPT inch (N1)	Tapered thread NPT inch (N2)	∅D	B	∅C	L ₁	L ₂	L	Price ₹/pcs
SA-22-16	3/4	1/2	16	32	35	22	19	25	250.00
SA-28-22	1	3/4	24.1	35	38	20	21	26	500.00
SA-36-28	1-1/4	1	30.3	46	50	20	21	26	800.00
SA-42-36	1-1/2	1-1/4	39	50	54	20	21	26	1,100.00
SA-54-42	2	1-1/2	44.8	63	67	20	22	26	1,500.00
SA-70-54	2-1/2	2	56.7	77	80	22	25	28	2,500.00
SA-82-70	3	2-1/2	72.2	91	94	25	25	32	4,500.00
SA-92-82	3-1/2	3	84.9	105	109	25	25	32	5,000.00
SA-104-92	4	3-1/2	97.4	115	119	25	25	32	6,000.00

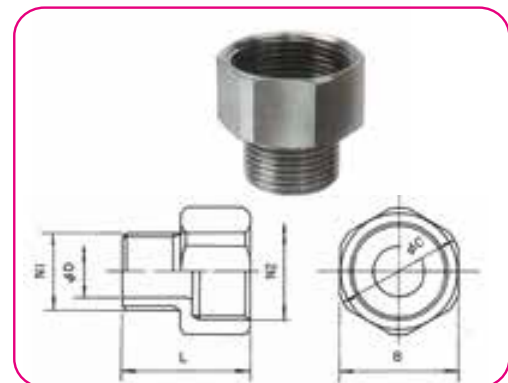

Flame-proof Explosion-Protected Reducers (d2G4)
 Type SR Reducers

TYPE	Tapered thread NPT inch (N1)	Tapered thread NPT inch (N2)	∅D	B	∅C	L	Price ₹/pcs
SR-22-16	1/2	3/4	15	32	35	35	500.00
SR-28-22	3/4	1	20	38	41	40	600.00
SR-36-28	1	1-1/4	26	46	50	44	1,000.00
SR-42-36	1-1/4	1-1/2	34	54	58	44	1,300.00
SR-54-42	1-1/2	2	39	67	73	44	1,650.00
SR-70-54	2	2-1/2	51	82	85	44	2,300.00
SR-82-70	2-1/2	3	67	99	103	56	4,500.00
SR-92-82	3	3-1/2	79	112	116	56	6,300.00
SR-104-92	3-1/2	4	88	124	128	56	7,200.00

CABLE GLANDS & CONDUIT FITTINGS

Material : Aluminium alloy die casting
Surface Treatment : Dyebblack (Zincart)

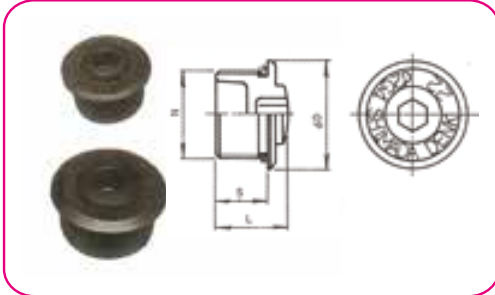

Flame-proof Explosion-Protected Blind Plugs (d2G4)
Type SBP **Blind Plugs**

TYPE	Tapered thread NPT inch (N)	∅D	s	L	Price บาท
SBP-16	1/2	28	15	20	200.00
SBP-22	3/4	33	16	22	300.00
SBP-28	1	40	19	25	400.00
SBP-36	1-1/4	50	22	29	500.00
SBP-42	1-1/2	57	22.5	32	800.00
SBP-54	2	71	25	39	1,000.00

Material : Cast iron
Surface Treatment : Electro deposition Coating

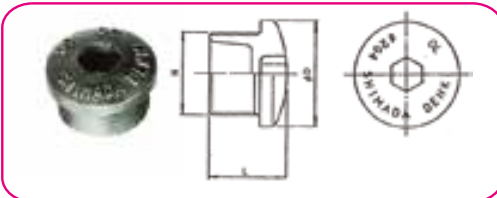

Flame-proof Explosion-Protected Blind Plugs (d2G4)
Type SMB **Blind Plugs**

TYPE	Tapered thread NPT inch (N)	∅D	L	Price บาท
SMB-16	1/2	81	43	1,350.00
SMB-22	3/4	94	43	1,650.00
SMB-28	3-1/2	107	48	2,000.00
SMB-36	4	120	48	2,500.00

Material : Carbon steel pipe
Surface Treatment : Zinc , Electro plated

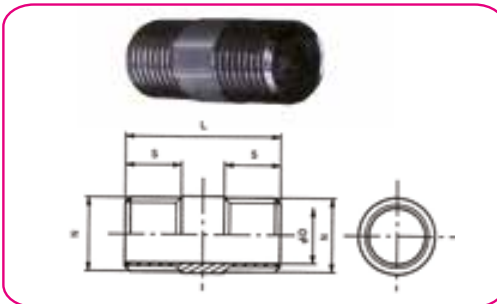

Flame-proof Explosion-Protected Nipples (d2G4)
Type SNP **Nipples**

TYPE	Tapered thread NPT inch (N)	∅D	s	L	Price บาท
SNP-16	1/2	16.1	19	50	260.00
SNP-22	3/4	21.6	19	50	400.00
SNP-28	1	27.6	23	61	500.00
SNP-36	1-1/4	35.7	23	61	600.00
SNP-42	1-1/2	41.6	23	61	800.00
SNP-54	2	52.9	25	65	1,200.00
SNP-70	2-1/2	67.9	25	65	2,500.00
SNP-82	3	80.7	30	80	3,800.00
SNP-92	3-1/2	93.2	35	90	6,000.00
SNP-104	4	105.3	35	90	7,000.00



Increased-Sfety Explosion Protected Flexible Conduit (eG4)
Type SFAC

Type	Threaded NPT inch	∅ D	B	∅C	L (mm)	Price บาท
SFAC-516	1/2	14	38	41	500	3,900.00
SFAC-716					700	4,300.00
SFAC-1016					1000	5,000.00
SFAC-522	3/4	20	46	50	500	5,100.00
SFAC-722					700	5,800.00
SFAC-1022					1000	6,700.00
SFAC-528	1	25	50	54	500	6,600.00
SFAC-728					700	7,500.00
SFAC-1028					1000	8,800.00
SFAC-536	1 1/4	32	58	63	500	9,200.00
SFAC-736					700	10,600.00
SFAC-1036					1000	12,500.00
SFAC-542	1 1/2	39	70	75	500	11,500.00
SFAC-742					700	13,500.00
SFAC-1042					1000	16,000.00

Type	Threaded NPT inch	∅ D	B	∅C	L (mm)	Price บาท
SFAC-554	2	51	86	89	500	17,500.00
SFAC-754					700	21,000.00
SFAC-1054					1000	26,000.00
SFAC-570	2 1/2	66	96	100	500	25,300.00
SFAC-770					700	29,500.00
SFAC-1070					1000	38,000.00
SFAC-582	3	78	111	113	500	45,000.00
SFAC-782					700	51,000.00
SFAC-1082					1000	60,000.00
SFAC-592	3 1/2	88	124	129	500	55,000.00
SFAC-792					700	62,000.00
SFAC-1092					1000	73,000.00
SFAC-5104	4	100	140	145	500	86,500.00
SFAC-7104					700	96,000.00
SFAC-10104					1000	109,500.00

CABLE GLANDS & CONDUIT FITTINGS



Liquid Tight Flexible Conduit **Type-MYLEX**
With Male & Female Connector

Type	Threaded NPT inch	Length mm.	Price ราคา
MYLEX-516	NPT 1/2	500	1,400.00
MYLEX-716		700	1,600.00
MYLEX-1016		1000	1,800.00
MYLEX-522	NPT 3/4	500	1,800.00
MYLEX-722		700	1,900.00
MYLEX-1022		1000	2,200.00
MYLEX-528	NPT 1	500	2,800.00
MYLEX-728		700	3,000.00
MYLEX-1028		1000	3,300.00
MYLEX-536	NPT 1-1/4	500	3,700.00
MYLEX-736		700	4,000.00
MYLEX-1036		1000	4,500.00
MYLEX-542	NPT 1-1/2	500	5,300.00
MYLEX-742		700	5,700.00
MYLEX-1042		1000	6,500.00
MYLEX-554	NPT 2	500	7,500.00
MYLEX-754		700	8,200.00
MYLEX-1054		1000	9,200.00

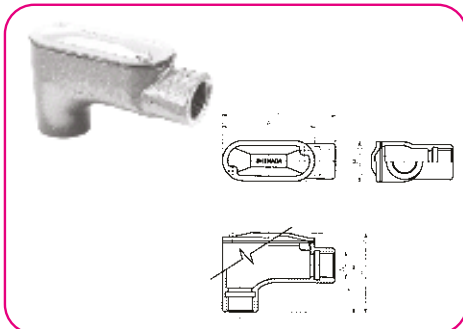

Flame-Proof Explosion Protected
Type ISEB (LB) Elbow (back)

Type	Threaded NPT inch	A	B	h	(H)	L	Price ราคา
ISEB-16	1/2	90	40	49	79	110	1,700.00
ISEB-22	3/4	90	40	47	79	110	1,800.00
ISEB-28	1	120	56	65	104	145	2,300.00
ISEB-36	1 1/4	120	56	65	109	145	3,300.00
ISEB-42	1 1/2	150	76	85	135	180	4,200.00
ISEB-54	2	150	76	85	141	180	4,600.00

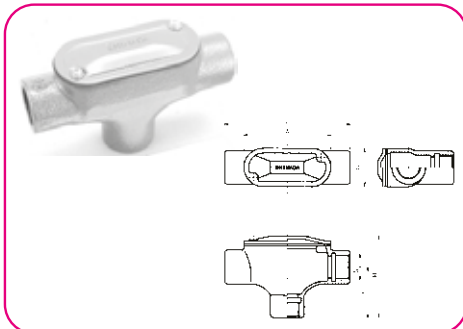

Flame-Proof Explosion Protected
Type ISET TEE (back)

Type	Threaded NPT inch	A	B	h	(H)	L	Price ราคา
ISET-16	1/2	90	40	49	79	130	1,900.00
ISET-22	3/4	90	40	47	79	130	2,100.00
ISET-28	1	120	56	65	104	170	2,700.00
ISET-36	1 1/4	120	56	65	109	170	3,900.00
ISET-42	1 1/2	150	76	85	135	210	4,600.00
ISET-54	2	150	76	85	141	210	6,000.00

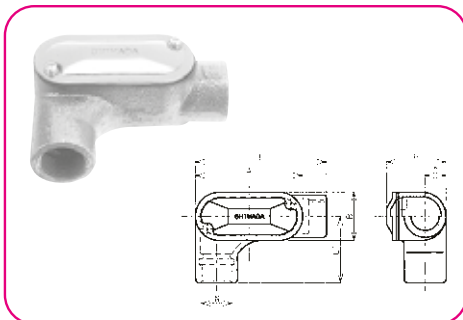

Flame-Proof Explosion Protected
Type ISER Elbow (Right)

Type	Threaded NPT inch	A	B	h	(H)	L1	L	Price ราคา
ISER-16	1/2	90	40	15	45	55	110	1,700.00
ISER-22	3/4	90	40	17.5	50	55	110	1,800.00
ISER-28	1	120	56	21	60	70	145	2,300.00
ISER-36	1 1/4	120	56	26	70	70	145	3,300.00
ISER-42	1 1/2	150	76	30	80	90	180	4,200.00
ISER-54	2	150	76	36	92	90	180	4,600.00

CABLE GLANDS & CONDUIT FITTINGS

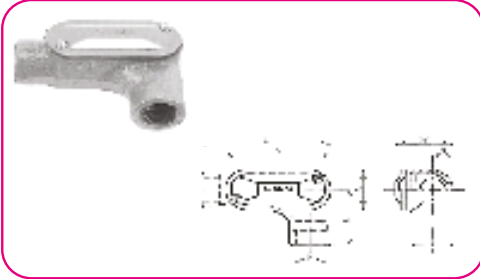

Flame-Proof Explosion Protected

Type ISER Elbow (Left)

Type	Threaded NPT inch	A	B	h	(H)	L1	L	Price ราคา
ISEL-16	1/2	90	40	15	45	55	110	1,700.00
ISEL-22	3/4	90	40	17.5	50	55	110	1,800.00
ISEL-28	1	120	56	21	60	70	145	2,300.00
ISEL-36	1 1/4	120	56	26	70	70	145	3,300.00
ISEL-42	1 1/2	150	76	30	80	90	180	4,200.00
ISEL-54	2	150	76	36	92	90	180	4,600.00

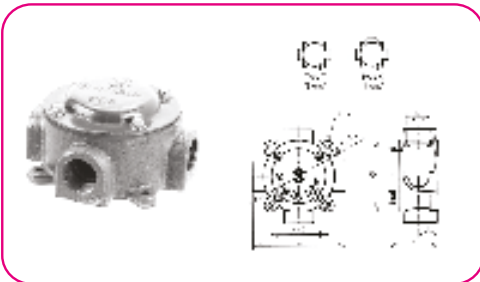

Increased-Safety Conduit Fittings (eG4)

Type ASGT Circular Surface Box Without Terminals

Type	Tapered thread NPT inch N	A	(B)	∅C	∅D	h	H	L	Price ราคา
ASGT, X-16	1/2	115	81	6	100	23	62	124	2,400 / 2,600
ASGT, X-22	3/4	115	81	6	100	23	62	124	2,600 / 2,900
ASGT, X-28	1	115	81	6	100	24	70	130	3,000 / 3,300
ASGT, X-36	1 1/4	140	98	9	120	32	82	144	5,500 / 6,100
ASGT, X-42	1 1/2	140	98	9	120	32	82	144	5,800 / 6,600
ASGT, X-54	2	170	120	9	140	38	102	180	8,300 / 9,400

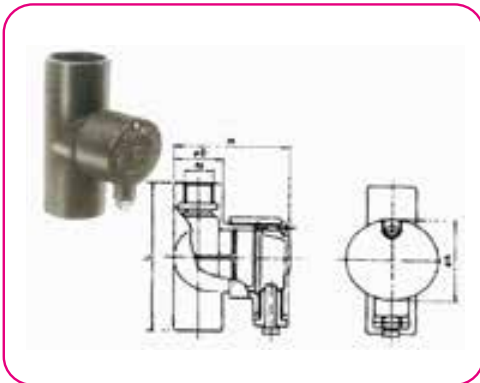

Flame-Proof Explosion Protected Sealing Fittings

Type SFD

Type	Threaded NPT inch	∅D	A	∅B	H	Price ราคา
SFD-16	1/2	35	65	85	120	4,400.00
SFD-22	3/4	35	65	85	120	5,000.00
SFD-28	1	45	65	97	130	5,500.00
SFD-36	1 1/4	52	80	108	140	6,000.00
SFD-42	1 1/2	60	80	115	160	7,900.00
SFD-54	2	70	80	127	190	8,800.00
SFD-70	2 1/2	90	80	154	176	11,000.00
SFD-82	3	105	80	162	177	12,100.00
SFD-92	3 1/2	115	110	182	200	14,300.00
SFD-104	4	130	110	200	220	19,800.00

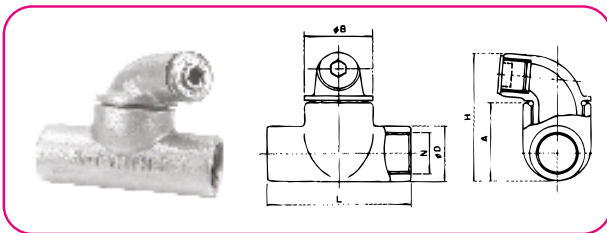

Flame-Proof Explosion Protected Sealing Fittings

Type SFG

Type	Threaded NPT inch	∅D	A	∅B	H	L	Price ราคา
SFG-16	1/2	30	47	43	79	90	1,500.00
SFG-22	3/4	35	52	43	84	90	1,800.00
SFG-28	1	45	58	43	90	103	2,200.00
SFG-36	1 1/4	55	70	51	112	125	3,500.00
SFG-42	1 1/2	60	77	51	120	125	3,900.00
SFG-54	2	70	93	51	136	155	5,000.00
SFG-70	2 1/2	90	125	75	178	176	7,700.00
SFG-82	3	105	133	76	190	177	9,900.00
SFG-92	3 1/2	115	132	100	187	200	14,300.00
SFG-104	4	130	151	100	206	220	17,600.00

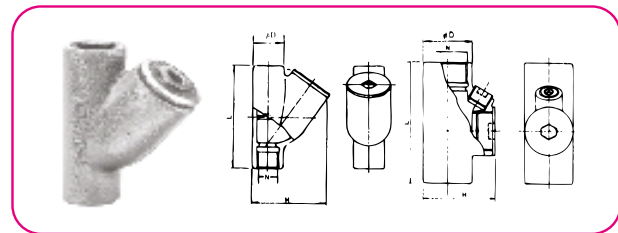

Flame-Proof Explosion Protected Sealing Fittings

Type SFT

Type	Threaded NPT inch	∅D	H	L	Price ราคา
SFT-16	1/2	30	73	100	1,200.00
SFT-22	3/4	35	75	100	1,400.00
SFT-28	1	43	87	110	1,800.00
SFT-36	1 1/4	53	95	140	2,900.00
SFT-42	1 1/2	58	98	145	3,300.00
SFT-54	2	70	115	160	4,200.00
SFT-70	2 1/2	90	141	190	7,000.00
SFT-82	3	106	151	190	8,800.00
SFT-92	3 1/2	122	173	193	13,200.00
SFT-104	4	122	183	224	16,500.00

HDPE CONDUIT AND FITTING



CLASS (MM.)	PN 3.2		PN4		PN6		PN10		PN16	
	S(MM.)	BHT/M	S(MM.)	BHT/M	S(MM.)	BHT/M	S(MM.)	BHT/M	S(MM.)	BHT/M
(1/2") 20	-	-	-	-	-	13	-	-	-	19
(3/4") 25	-	-	-	-	1.6	16	2.3	22	3.5	30
(1") 32	-	-	1.3	21	1.9	22	2.9	33	4.4	47
(1"-1/4")40	-	-	1.6	25	2.3	34	3.7	52	5.5	73
(1"-1/2")50	1.6	31	2.0	38	9	53	4.6	80	6.9	114
(2") 63	2.0	48	2.4	56	3.6	83	5.8	114	8.6	171
(2-1/2") 75	2.3	66	2.9	81	4.3	116	6.8	168	10.3	241
(3") 90	2.8	95	3.5	116	5.1	166	8.2	227	12.3	328
(4") 110	3.4	141	4.2	170	6.3	248	10.0	337	15.1	487
(5") 125	3.9	183	4.8	220	7.1	318	11.4	434	17.1	630
(5") 140	4.3	226	5.4	278	8.0	399	12.7	544	19.2	789
(6") 160	4.9	292	6.2	363	9.1	520	14.6	709	21.9	1,028
(8") 180	5.6	373	7.0	462	10.2	655	16.4	900	24.6	1,301
(8") 200	6.2	463	7.7	561	11.4	810	18.2	1,104	27.3	1,608

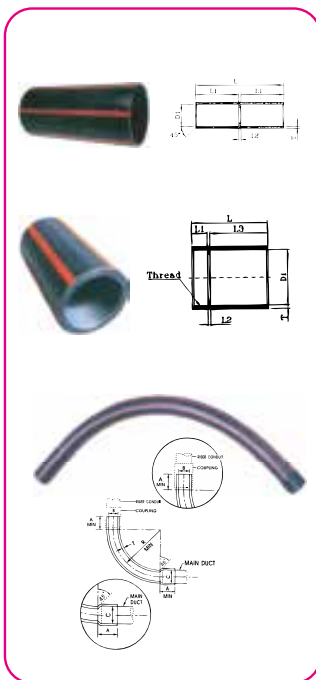

ขนาด (มม.)	ข้อต่อสวม พีอี A	ต่อเกลียวสวม พีอี B	ข้อโค้งไฟฟ้า พีอี 90 องศา
	ราคา/อัน	ราคา/อัน	ราคา/อัน
20	22.00	25.00	-
25	24.00	27.00	96.00
32	28.00	32.00	108.00
40	35.00	40.00	120.00
50	45.00	50.00	165.00
63	53.00	58.00	215.00
75	76.00	83.00	312.00
90	103.00	113.00	579.00
110	142.00	149.00	898.00
125	162.00	170.00	1,152.00
140	244.00	256.00	1,433.00
160	263.00	276.00	1,860.00
180	400.00	400.00	3,490.00
200	505.00	-	5,730.00

HDPE CONDUIT AND FITTING

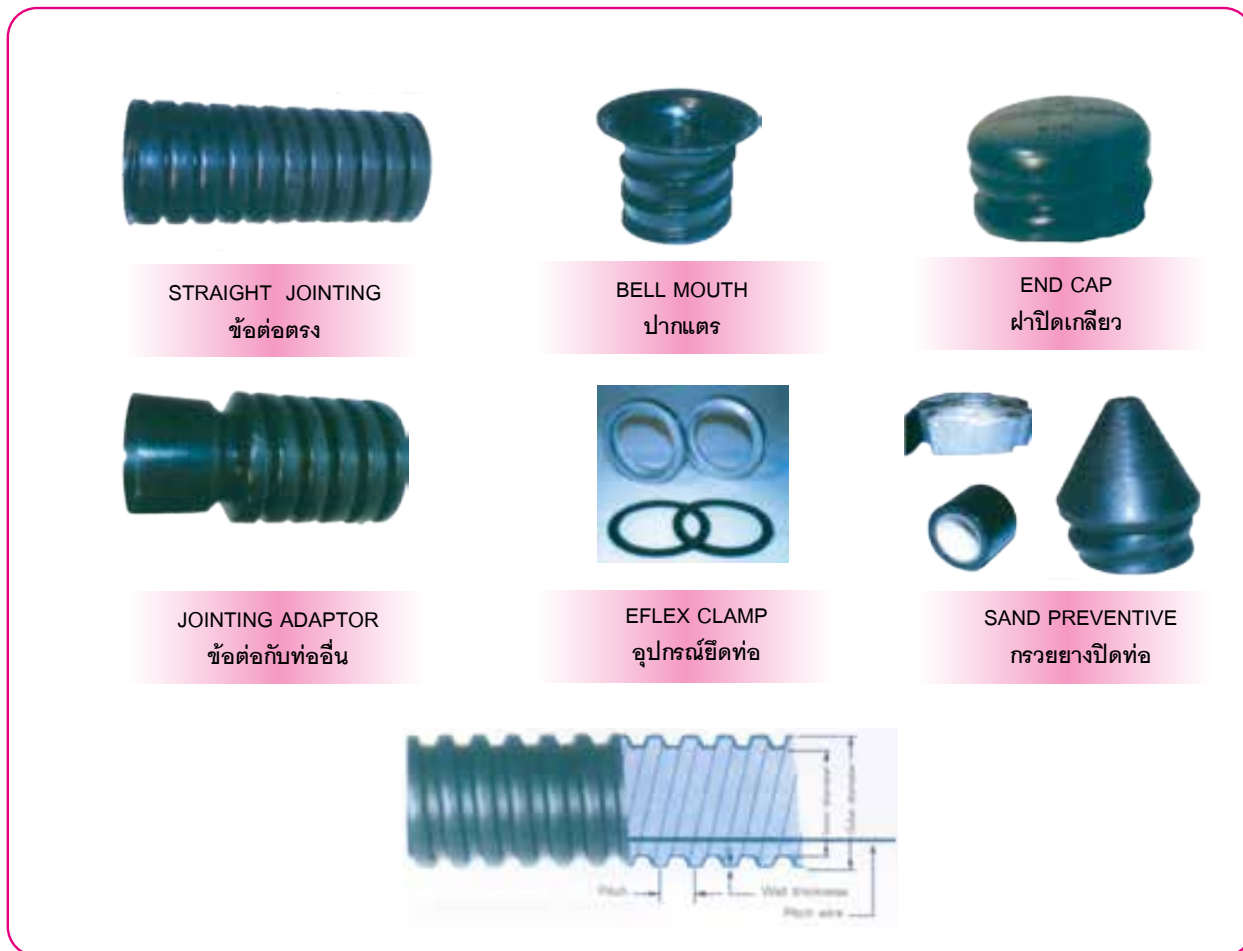

EFLEX Is Available in Many Sizes Ranging from 30 to 150

SIZE(I.D.)		EFLEX (B/M)	STRAIGHT JOINTING (B/PC)	BELL MOUTH (B/M)	ENDCAP (B/M)	WATERPROOF SEALING (SAND PREVENTIVE) (B/PC)	JOINTING ADAPTOR (B/M)	EFLEX CLAMP (B/PC)
INCH	MM.							
1	30	95.00	47.00	42.00	39.00	110.00	52.00	320.00
2	50	128.00	80.00	50.00	52.00	220.00	78.00	460.00
3	80	194.00	100.00	75.00	66.00	295.00	120.00	630.00
4	100	275.00	127.00	120.00	70.00	390.00	210.00	940.00
5	125	385.00	156.00	150.00	92.00	525.00	240.00	1,115.00
6	150	462.00	234.00	240.00	126.00	620.00	275.00	1,210.00

CONDUIT FITTING & ACCESSORIES



EMT, IMC, RSC
CONDUIT
ท่อเหล็ก

EMT , IMC , RSC
CONDUIT (PAT)

Size Inch	EMT Type	IMC Type	RSC Type
	Price/ราคา	Price/ราคา	Price/ราคา
1/2	133.00	282.00	374.00
3/4	192.00	375.00	478.00
1	273.00	506.00	702.00
1 1/4	476.00	653.00	906.00
1 1/2	555.00	802.00	1,080.00
2	688.00	1,096.00	1,446.00
2 1/2	-	1,714.00	2,151.00
3	-	2,122.00	2,764.00
3 1/2	-	2,440.00	3,625.00
4	-	2,802.00	4,073.00
5	-	-	5,858.00
6	-	-	7,010.00
8	-	-	-



EMT, IMC, RSC
ELBOWS CONDUIT
ท่อโค้ง

EMT , IMC , RSC
ELBOWS CONDUIT

Size Inch	Elbows Type EMT	Elbows Type IMC	Elbows Type RSC
	Price/ราคา	Price/ราคา	Price/ราคา
1/2	22.00	37.00	45.00
3/4	30.00	45.00	79.00
1	45.00	72.00	132.00
1 1/4	72.00	96.00	199.00
1 1/2	96.00	142.00	238.00
2	130.00	190.00	382.00
2 1/2	-	530.00	869.00
3	-	752.00	1,410.00
3 1/2	-	1,430.00	1,920.00
4	-	1,720.00	2,800.00
5	-	-	5,500.00
6	-	-	-
8	-	-	-



FLEXIBLE STEEL
CONDUIT
ท่ออ่อนเหล็ก



FLEXIBLE LIQUID
CONDUIT
ท่ออ่อนกันน้ำ

FLEXIBLE STEEL CONDUIT
FLEXIBLE LIQUID CONDUIT

Size Inch	Flexible (เหล็ก) Steel Type	Flexible (กันน้ำ) Liquid Type
	Price(m)/ราคา(เมตร)	Price(m)/ราคา(เมตร)
1/2	18.00	106.00
3/4	24.00	138.00
1	36.00	230.00
1 1/4	66.00	276.00
1 1/2	76.00	368.00
2	110.00	460.00
2 1/2	200.00	920.00
3	240.00	1,380.00
3 1/2	-	-
4	420.00	1,840.00
5	-	-
6	-	-
8	-	-



CLAMP
แคล้ม



TREADED
เกลียว

Entrance Cap (หัวงูเห่า)

Size Inch	Entrance Cap Thread Type	
	Clamp	Treaed
	Price/ราคา	
1/2	40.00	40.00
3/4	56.00	56.00
1	70.00	70.00
1 1/4	90.00	90.00
1 1/2	110.00	110.00
2	190.00	190.00
2 1/2	-	400.00
3	-	550.00
3 1/2	-	600.00
4	-	600.00
5	-	1,900.00
6	-	2,500.00
-	-	-

GVALVANIZED STEEL CONDUIT AND FITTING



IMC
COUPLING
ข้อต่อหนา



EMT
COUPLING
ข้อต่อบาง



EMT RAIN TIGHT
COUPLING
ข้อต่อบางกันน้ำ



ELECKSON
COUPLING
(H.D.G.)
ข้อต่ออีริกสัน

Size inch	IMC Type	EMT Type	EMT RT Type	ELICKSON Type
	Price/ราคา	Price/ราคา	Price/ราคา	Price/ราคา
1/2	24.00	8.50	26.00	80.00
3/4	30.00	14.00	36.00	100.00
1	40.00	18.00	54.00	120.00
1 1/4	70.00	38.00	80.00	180.00
1 1/2	80.00	46.00	144.00	220.00
2	110.00	72.00	184.00	280.00
2 1/2	250.00	-	-	390.00
3	290.00	-	-	520.00
3 1/2	400.00	-	-	780.00
4	440.00	-	-	1,000.00
5	720.00	-	-	1,800.00
6	1,100.00	-	-	2,400.00



EMT
CONNECTOR



EMT CONNECTOR
RAINTIGHT



FLEXIBLE LIQUID
TIGHT CONNECTOR



MN CONNECTOR



FLEXIBLE STEEL
CONNECTOR

Size inch	EMT Connector	EMT Connector RT.	Flexible LT. Connector	MN Connector	Flexible Steel Connector
	Price/ราคา	Price/ราคา	Price/ราคา	Price/ราคา	Price/ราคา
1/2	8.00	22.00	52.00	12.00	12.00
3/4	13.00	30.00	72.00	32.00	24.00
1	17.00	46.00	120.00	120.00	36.00
1 1/4	34.00	76.00	200.00	-	80.00
1 1/2	44.00	120.00	300.00	-	120.00
2	70.00	170.00	500.00	-	150.00
2 1/2	-	-	1,000.00	-	240.00
3	-	-	1,200.00	-	320.00
3 1/2	-	-	-	-	600.00
4	-	-	1,600.00	-	600.00

GVALVANIZED STEEL CONDUIT AND FITTING



TYPE FS



TYPE FSS



TYPE FSC



TYPE FSCC

Size inch	Type and Size inch	Price / ราคา	Type and Size inch	Price / ราคา
1/2	FS 2 X 4	80.00	FSC 2 X 4	90.00
3/4		80.00		90.00
1		90.00		100.00
1/2	FS 4 X 4	120.00	FSC 4 X 4	130.00
3/4		120.00		130.00
1		130.00		140.00
1/2	FSS 2 X 4	90.00	FSCC 2 X 4	100.00
3/4		90.00		100.00
1		-		-
1/2	FSS 4 X 4	130.00	FSCC 4 X 4	140.00
3/4		130.00		140.00
1		-		-



GUA
1 ทาง



GUAC
2 ทาง



GUAL
2 ทางจาก



GUAT
3 ทาง



GUAX
4 ทาง

CONDUIT JUNCTION BOXES AND HOT DIP GALVANIZED (บ็อกซ์กลมกันน้ำชุบซิงค์และชุบสังกะสี)

Size inch	GUA		GUAC		GUAL		GUAT		GUAX	
	ZINC	HDG	ZINC	HDG	ZINC	HDG	ZINC	HDG	ZINC	HDG
	Price / ราคา		Price / ราคา		Price / ราคา		Price / ราคา		Price / ราคา	
1/2	110.00	480.00	120.00	480.00	120.00	480.00	130.00	540.00	140.00	600.00
3/4	110.00	480.00	120.00	480.00	120.00	480.00	130.00	540.00	140.00	600.00
1	120.00	520.00	140.00	520.00	140.00	520.00	160.00	600.00	170.00	660.00
1 1/4	310.00	1,360.00	350.00	1,360.00	350.00	1,360.00	400.00	1,500.00	470.00	1,650.00
1 1/2	310.00	1,360.00	350.00	1,360.00	350.00	1,360.00	400.00	1,500.00	470.00	1,650.00
2	680.00	1,580.00	800.00	1,580.00	800.00	1,580.00	800.00	1,800.00	980.00	2,000.00
2 1/2	1,460.00	3,300.00	1,540.00	1,580.00	1,540.00	1,540.00	1,600.00	3,600.00	1,680.00	4,000.00

GVALVANIZED STEEL CONDUIT AND FITTING



LB

LL

LR

OT

CONDUIT OUTLET GALVANIZED (คอนduit เอ้าท์เลทบ็อกซ์กันน้ำและชุบสังกะสี)

Size inch	Type LB		Type LL		Type LR		Type OT	
	ZINC	HDG	ZINC	HDG	ZINC	HDG	ZINC	HDG
	Price / ราคา		Price / ราคา		Price / ราคา		Price / ราคา	
1/2	44.00	280.00	44.00	280.00	44.00	280.00	50.00	320.00
3/4	58.00	340.00	58.00	340.00	58.00	340.00	68.00	420.00
1	78.00	520.00	78.00	520.00	78.00	520.00	84.00	640.00
1 1/4	140.00	820.00	140.00	820.00	140.00	820.00	150.00	960.00
1 1/2	160.00	860.00	160.00	860.00	160.00	860.00	170.00	1,240.00
2	280.00	1,320.00	280.00	1,320.00	280.00	1,320.00	300.00	1,800.00
2 1/2	440.00	2,200.00	440.00	2,200.00	440.00	2,200.00	580.00	3,100.00
3	560.00	2,940.00	560.00	2,940.00	560.00	2,940.00	680.00	3,700.00
3 1/2	1,000.00	4,300.00	1,000.00	4,300.00	1,000.00	4,300.00	1,340.00	5,700.00
4	1,000.00	4,400.00	1,000.00	4,400.00	1,000.00	4,440.00	1,340.00	5,900.00
5	2,400.00	-	2,400.00	-	2,400.00	-	3,400.00	-
6	4,800.00	-	4,800.00	-	4,800.00	-	6,000.00	-



EMT,IMC C Straps

IMC STRAPS

BUSHING

LOCK NUT

Size Inch	EMT,IMC C Straps	IMC Straps 1 AND 2 Hole	EMT Straps 1 AND 2 Hole
	Price / ราคา	Price / ราคา	Price / ราคา
1/2	10.50	1.50	1.50
3/4	12.00	1.80	1.80
1	13.00	2.80	2.80
1 1/4	18.00	5.00	5.00
1 1/2	20.00	7.00	7.00
2	22.00	9.00	9.00
2 1/2	24.00	17.00	-
3	30.00	20.00	-
3 1/2	44.00	26.00	-
4	50.00	28.00	-

Size Inch	Bushing	Lock nut
	Price / ราคา	Price / ราคา
1/2	4.00	6.50
3/4	5.00	7.50
1	9.00	10.00
1 1/4	14.00	14.00
1 1/2	19.00	17.00
2	27.00	22.00
2 1/2	46.00	54.00
3	60.00	68.00
3 1/2	130.00	100.00
4	140.00	110.00
5	190.00	150.00
6	390.00	280.00

GVALVANIZED STEEL CONDUIT AND FITTING

Reducing Bushings



Size Inch	Price ราคา
3/4-1/2	18.00
1-1/2	26.00
1-3/4	26.00
1 1/4-1/2	50.00
1 1/4-3/4	50.00
1 1/4-1	50.00
1 1/2-1/2	60.00
1 1/2-3/4	60.00
1 1/2-1	55.00
1 1/2-1 1/4	55.00
2-1/2	120.00
2-3/4	120.00
2-1	120.00
2-1/4	110.00
2-1/2	110.00



FS.Cover

Size Inch	Price ราคา
2 X 4	20.00
4 X 4	40.00



Reducing Washer

Size Inch	Price ราคา
3/4-1/2	0.55
1-1/2	1.10
1-3/4	1.10



Cover

Size Inch	Price ราคา
2 X 4	4.00
4 X 4	7.00
Oct.Size	7.00



	Hand Box Price / ราคา	Square Box Price / ราคา	Octagon Box Price / ราคา
คืน	14.00	23.00	18.00
ลิ้น	18.00	25.00	24.00

LOCATION

GUNKUL

not only the energy, we care

บริษัท กันกุลเอ็นเนอร์จี้ จำกัด (มหาชน)
ตั้งอยู่ที่อาคารเพิร์ล แบงก์คือก ชั้นที่ 8



GUNKUL
not only the energy, we care

E-MAIL : GK_ENG@GUNKUL.COM

WEBSITE : WWW.GUNKUL.COM



GUNKUL

not only the energy, we care

GUNKUL ENGINEERING PUBLIC COMPANY LIMITED
Pearl Bangkok Building
8th Floor, 1177, Phaholyothin Road,
Phayathai, Phayathai
Bangkok 10400 Thailand

G.K. ASSEMBLY COMPANY LIMITED
110/9-10 Moo 2 Chongtanom Road,
Mahasawat Sub-district Bankruai District
Nonthaburi 11130 Thailand
(Factory)
Tel 02-985-2254



TEL: **02 242 5800**
FACEBOOK: **GUNKUL**
WEBSITE : **WWW.GUNKUL.COM**